



**No Waste. More Labels.
Less Effort.**

BradyPrinter i3300 Industrial Label Printer

No waste. More labels. Less effort.

Picture your ideal label printing scenario – the labels and ribbons snap into place, there's no calibration process, you don't have to throw away blank labels before you actually print one. Ideal is now real with the BradyPrinter i3300 Industrial Label Printer. This mid-volume industrial label printer makes your identification projects easy, fast and affordable. Enjoy a variety of time- and money-saving advantages, including:

- **No waste printing** – with print smart technology, you get auto setup and calibration without throwing out blank labels
- **Fast material changeovers** – foolproof drop-in label rolls and ribbons snap into place for 20-second material changeovers
- **Full-facility identification** – complete all of your identification tasks, from wires, panels and products to safety and facility labels, with one convenient and efficient tool

The complete BradyPrinter i3300 solution



BradyPrinter i3300
Industrial Label
Printer

Pages 2-6



Compatible labels
Product and Electronic Labels
Pages 8-11

Wire and Panel Labels
Pages 12-22

Safety and Facility Labels
Pages 23-31

Laboratory Specimen Labels
Pages 32-35



Compatible ribbons
Pages 36-37



Software for label
creation and data
integration

Page 38



Printer technical
specifications

Page 39

BradyPrinter i3300

INDUSTRIAL LABEL PRINTER

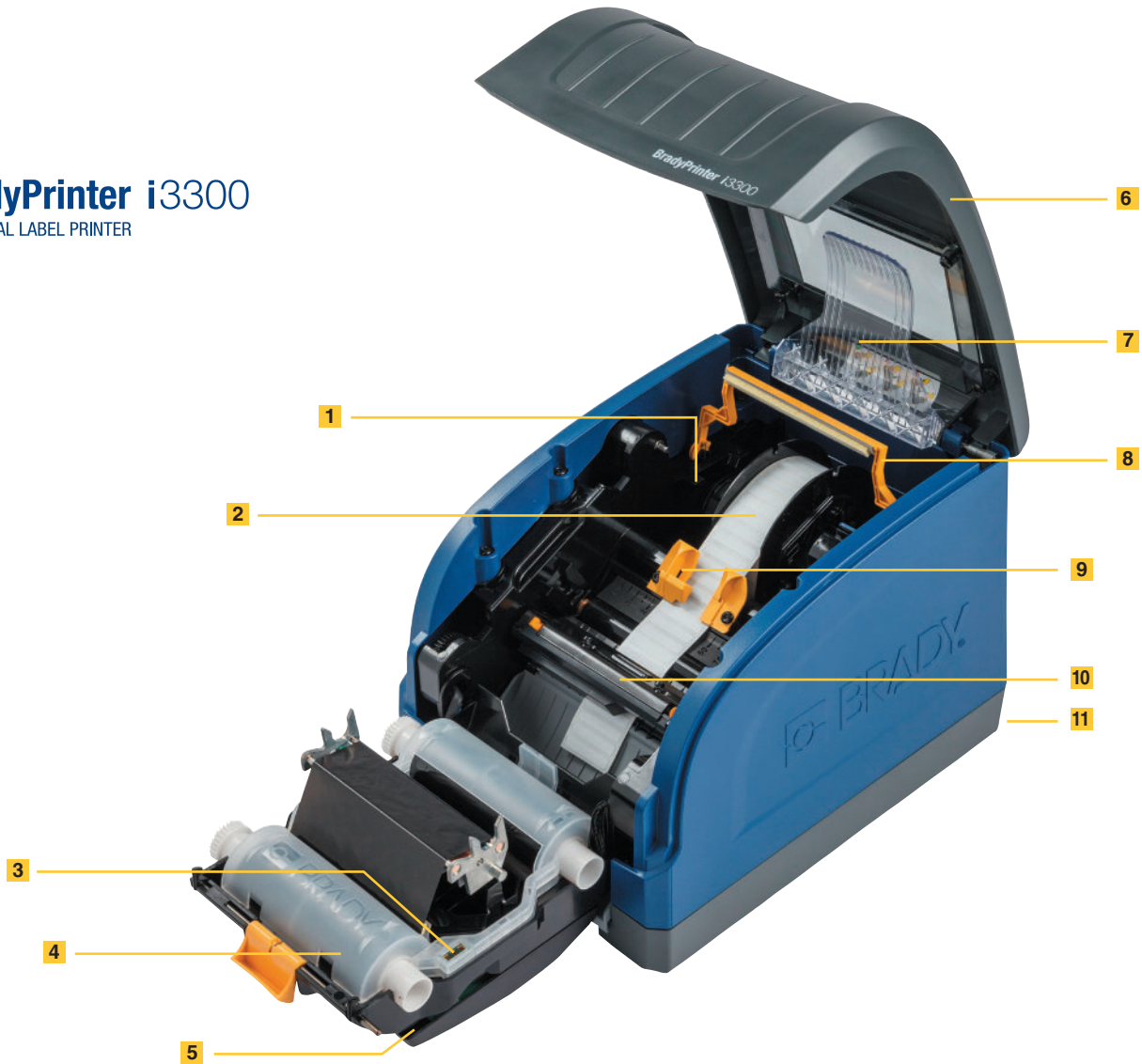

- 1 Media roll cartridge with auto part detection**
Printer auto-detects installed label part, communicating printer setting and part setup information to both printer and Brady software
- 2 15-second media roll changeover**
Media cartridge roll drops in and out of place quickly with minimal thread-through, no sensor adjustment, no calibration and no label waste
- 3 Ribbon cartridge with auto part detection**
Printer auto-detects installed ribbon part, then sets correct print heat level and shows a warning if incorrect ribbon is used
- 4 5-second ribbon changeover**
Ribbon cartridge snaps into place in one quick motion and guarantees the ink always faces the right direction to the print head
- 5 Color touchscreen control panel**
Icons and sliders for easy printer setting adjustments and on-display part information and amount remaining

- 6 Top-loading design**
Reduces footprint in your work area and simplifies media alignment and loading
- 7 Double-sided PermaSleeve® bridge**
Lowered into place to allow printing second side of double-sided PermaSleeve wire markers
- 8 Media wiper arm**
Ensures dust-free surface and high print quality when printing large ink areas on continuous media. Felt pads are field-replaceable
- 9 Sensors located in guides**
Label sensor is always correctly positioned as guides are closed, meaning no sensor location trial and error, no calibration required and no wasted labels
- 10 Integrated auto cutter**
Built-in cutter for complete cut-through of media between labels, at end of job, or no cut at all
- 11 Interface options**
2x USB, 1x USB 2.0, 1x Ethernet (back of printer)



Prints on first label

No wasting labels with print smart technology

Print on every label or sleeve – no more blank first label. With print smart technology, the printer, labels, ribbons and software all work together for efficient label setup. It's all in the smart chip embedded in our materials – it stores the material size, type, color, quantity and compatibility, and sets proper burn settings, sensor alignment and print speed. When installed, the chip sends that information to the printer and desktop software and auto calibrates without wasting any labels – and you get fast material setup and creation, without the waste.

Get no-hassle, 20-second material changeovers

Forget fumbling around with ribbon rolls that are great at rolling away or threading material around rollers or print heads. Switch to a new way of material changeovers with the BradyPrinter i3300 Industrial Label Printer. The easy-to-load label rolls and self-contained ribbons snap into place for easy 20-second material changeovers without cumbersome sensor adjustments. Switch materials frequently throughout the day? You'll save time to work on your more important tasks.



Easy drop-in loading

The right label from the right company

Nothing leaves Brady's doors without meeting the highest quality standards. Backed by more than 100 years of identification experience and rigorous R&D testing, Brady manufactures materials you can trust.



That strong background of material development allows us to create materials for all of your applications throughout your facility. Add the printing versatility of the BradyPrinter i3300 Industrial Label Printer, and you get a convenient tool for facility-wide identification that offers more than 825 parts and 70 material options, and additional custom label options for a variety of applications, including:

Product ID and production line applications



- Metallized labels and rating plates
- Work-in-process and barcode labels
- QA testing labels
- Anti-tamper labels
- Product labels

Electronics and PC board applications

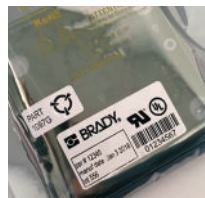
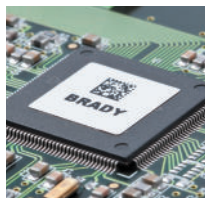
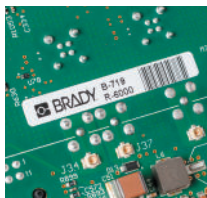

- Polyimide labels
- Electrostatic dissipative labels
- Polyester labels
- Removable polyimide labels
- PC board component labels

Electrical and automation applications



- Wire markers and sleeves
- Inside panel labels
- Push button / engraved plate alternative labels
- Panel rating plate materials

Safety, maintenance and facility applications



- Pipe markers
- Safety signs and warnings
- Lean / 5S labels
- Floor marking
- GHS chemical labels

Laboratory and sample tracking applications

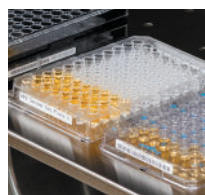

- Cryo tube and vial labels
- Labels for humidity, moisture, water bath and autoclave
- Slide labels / solvent-resistant labels
- Removable labels for glassware

BradyPrinter i3300 Label Printer and Accessories

Printer Part Numbers

Catalog #	Description
150640	BradyPrinter i3300 with auto cutter, Wi-Fi version. Bundled with Brady Workstation Product and Wire ID Suite label creation software
150642	BradyPrinter i3300 with auto cutter, Wi-Fi version. Bundled with Brady Workstation Laboratory ID Suite label creation software
150643	BradyPrinter i3300 with auto cutter, Wi-Fi version. Bundled with Brady Workstation Safety and Facility ID Suite label creation software
150645	BradyPrinter i3300 with auto cutter, Wi-Fi version. Bundled with Brady Workstation GHS Label App label creation software
150639	BradyPrinter i3300 with auto cutter, Wi-Fi version. Bundled with Brady Workstation Scan and Print Suite label creation software and CR2600 Scanner
149552	BradyPrinter i3300 with auto cutter, Wi-Fi version (includes Brady Workstation Basic design suite)

See page 38 for descriptions of Brady Workstation suites. Base printer ships with power cord, USB cable, cleaning kit, cutter cleaning tool, quickstart guide, product CD with full user manual.

Brady WorkStation does not require the use of a driver. A Windows® driver for BradyPrinter i3300 is available if needed via free download from BradyID.com.



Accessories

Catalog #	Description
PCK-6	Cleaning swabs soaked in IPA (pkg of 50 swabs)
120994	Padded rolling case with handle and supplies pockets
B31-WIPER	5-pack of replaceable media wipers (fits BradyPrinter i3300)
B31-CCT	Cleaning tool for auto cutter blade



Windows® is a registered trademark of Microsoft Corporation.



Polyester Labels (B-422, B-423, B-430, B-432, B483, B-484A and B-489)

• For product, circuit board and component ID as well as for general purpose industrial identification.

B-423, B-483, B-489: Service temp: -94°F to 248°F

Agency approvals:   

B-430, B-432: Service temp: -40°F to 212°F

Agency approvals:   

B-484A: Service temp: -40°F to 240°F

Agency approvals:  

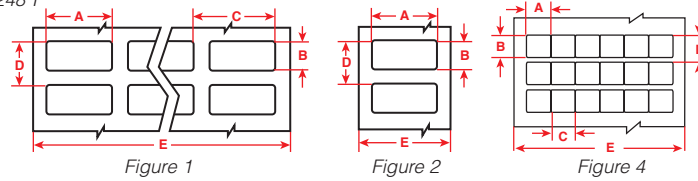

Diagram	Catalog #	B#	Color	Label Width A Inch (mm)	Label Height B Inch (mm)	Horiz. Repeat C Inch (mm)	Vert. Repeat D Inch (mm)	Web Width E Inch (mm)	Labels Per Row	Labels Per Roll	Rec. Ribbon
Standard adhesive (B-423 gloss white):											
Fig. 4	B33-11-423	B-423	Gloss White	0.250 (6.4)	0.250 (6.4)	0.250 (6.4)	0.375 (9.5)	3.200 (81.3)	12	15000	B30-R6000
Fig. 1	B33-38-423	B-423	Gloss White	0.375 (9.5)	0.375 (9.5)	0.438 (11.1)	0.475 (12.1)	3.200 (81.3)	9	5000	B30-R6000
Fig. 1	B33-149-423	B-423	Gloss White	0.500 (12.7)	0.500 (12.7)	0.600 (15.2)	0.600 (15.2)	2.500 (63.5)	4	5000	B30-R6000
Fig. 1	B33-1-423	B-423	Gloss White	0.750 (19.1)	0.250 (6.4)	0.800 (20.3)	0.350 (8.9)	3.350 (85.1)	4	5000	B30-R6000
Fig. 2	B33-46-423	B-423	Gloss White	0.750 (19.1)	0.250 (6.4)	-	0.350 (8.9)	0.950 (24.1)	1	5000	B30-R6000
Fig. 2	B33-49-423	B-423	Gloss White	0.900 (22.9)	0.250 (6.4)	-	0.350 (8.9)	1.100 (27.9)	1	5000	B30-R6000
Fig. 2	B33-103-423	B-423	Gloss White	1.000 (25.4)	0.250 (6.4)	-	0.350 (8.9)	1.200 (30.5)	1	5000	B30-R6000
Fig. 1	B33-3-423	B-423	Gloss White	1.000 (25.4)	0.375 (9.5)	1.075 (27.3)	0.475 (12.1)	3.350 (85.1)	3	5000	B30-R6000
Fig. 1	B33-5-423	B-423	Gloss White	1.000 (25.4)	0.500 (12.7)	1.075 (27.3)	0.600 (15.2)	3.350 (85.1)	3	5000	B30-R6000
Fig. 2	B33-43-423	B-423	Gloss White	1.250 (31.8)	0.250 (6.4)	-	0.350 (8.9)	1.450 (36.8)	1	5000	B30-R6000
Fig. 1	B33-29-423	B-423	Gloss White	1.250 (31.8)	0.375 (9.5)	1.300 (33.0)	0.475 (12.1)	2.750 (69.9)	2	5000	B30-R6000
Fig. 2	B33-45-423	B-423	Gloss White	1.500 (38.1)	0.250 (6.4)	-	0.350 (8.9)	1.700 (43.2)	1	5000	B30-R6000
Fig. 2	B33-72-423	B-423	Gloss White	1.750 (44.5)	0.250 (6.4)	-	0.350 (8.9)	1.950 (49.5)	1	5000	B30-R6000
Fig. 2	B33-53-423	B-423	Gloss White	2.000 (50.8)	0.500 (12.7)	-	0.600 (15.2)	2.200 (55.9)	1	2500	B30-R6000
Fig. 2	B33-17-423	B-423	Gloss White	2.000 (50.8)	1.000 (25.4)	-	1.125 (28.6)	2.200 (55.9)	1	1500	B30-R6000
Fig. 2	B33-18-423	B-423	Gloss White	3.000 (76.2)	1.000 (25.4)	-	1.125 (28.6)	3.200 (81.3)	1	1500	B30-R6000
Fig. 2	B33-19-423	B-423	Gloss White	3.000 (76.2)	2.000 (50.8)	-	2.125 (54.0)	3.200 (81.3)	1	500	B30-R6000
Fig. 2	B33-55-423	B-423	Gloss White	4.000 (101.6)	2.000 (50.8)	-	2.125 (54.0)	4.200 (106.7)	1	750	B30-R6000
Standard adhesive (B-430 clear):											
Fig. 1	B33-5-430	B-430	Clear	1.000 (25.4)	0.500 (12.7)	1.075 (27.3)	0.625 (15.9)	3.350 (85.1)	3	5000	B30-R6000
Fig. 2	B33-17-430	B-430	Clear	2.000 (50.8)	1.000 (25.4)	-	1.125 (28.6)	2.200 (55.9)	1	1500	B30-R6000
Fig. 2	B33-18-430	B-430	Clear	3.000 (76.2)	1.000 (25.4)	-	1.125 (28.6)	3.200 (81.3)	1	1500	B30-R6000
Stronger adhesive for textured surfaces (B-422 gloss white):											
Fig. 1	B33-149-422	B-422	Gloss White	0.500 (12.7)	0.500 (12.7)	0.600 (15.2)	0.600 (15.2)	2.500 (63.5)	4	5000	B30-R6000
Fig. 1	B33-5-422	B-422	Gloss White	1.000 (25.4)	0.500 (12.7)	1.075 (27.3)	0.600 (15.2)	3.350 (85.1)	3	5000	B30-R6000
Fig. 1	B33-147-422	B-422	Gloss White	1.500 (38.1)	0.375 (9.5)	1.650 (41.9)	0.475 (12.1)	3.350 (85.1)	2	2500	B30-R6000
Fig. 2	B33-102-422	B-422	Gloss White	1.500 (38.1)	0.375 (9.5)	-	0.500 (12.7)	1.700 (43.2)	1	2500	B30-R6000
Fig. 2	B33-136-422	B-422	Gloss White	1.500 (38.1)	0.750 (19.1)	-	0.875 (22.2)	1.700 (43.2)	1	1500	B30-R6000
Fig. 2	B33-17-422	B-422	Gloss White	2.000 (50.8)	1.000 (25.4)	-	1.125 (28.6)	2.200 (55.9)	1	1500	B30-R6000
Fig. 2	B33-18-422	B-422	Gloss White	3.000 (76.2)	1.000 (25.4)	-	1.125 (28.6)	3.200 (81.3)	1	1500	B30-R6000
Fig. 2	B33-19-422	B-422	Gloss White	3.000 (76.2)	2.000 (50.8)	-	2.125 (54.0)	3.200 (81.3)	1	500	B30-R6000
Fig. 2	B33-76-422	B-422	Gloss White	4.000 (101.6)	3.000 (76.2)	-	3.125 (79.4)	4.200 (106.7)	1	500	B30-R6000
Stronger adhesive for textured surfaces (B-432 clear):											
Fig. 1	B33-149-432	B-432	Clear	0.500 (12.7)	0.500 (12.7)	0.600 (15.2)	0.625 (15.9)	2.500 (63.5)	4	5000	B30-R6000
Fig. 1	B33-5-432	B-432	Clear	1.000 (25.4)	0.500 (12.7)	1.075 (27.3)	0.600 (15.2)	3.350 (85.1)	3	5000	B30-R6000
Fig. 2	B33-17-432	B-432	Clear	2.000 (50.8)	1.000 (25.4)	-	1.125 (28.6)	2.200 (55.9)	1	1500	B30-R6000
Fig. 2	B33-18-432	B-432	Clear	3.000 (76.2)	1.000 (25.4)	-	1.125 (28.6)	3.200 (81.3)	1	1500	B30-R6000
Fig. 2	B33-19-432	B-432	Clear	3.000 (76.2)	2.000 (50.8)	-	2.125 (54.0)	3.200 (81.3)	1	500	B30-R6000
Ultra-aggressive adhesive for highly textured surfaces (B-483 gloss white):											
Fig. 1	B33-149-483	B-483	Gloss White	0.500 (12.7)	0.500 (12.7)	0.600 (15.2)	0.600 (15.2)	2.500 (63.5)	4	5000	B30-R6000
Fig. 1	B33-5-483	B-483	Gloss White	1.000 (25.4)	0.500 (12.7)	1.075 (27.3)	0.600 (15.2)	3.350 (85.1)	3	5000	B30-R6000
Fig. 2	B33-17-483	B-483	Gloss White	2.000 (50.8)	1.000 (25.4)	-	1.125 (28.6)	2.200 (55.9)	1	1500	B30-R6000
Fig. 2	B33-7-483	B-483	Gloss White	2.750 (69.9)	1.250 (31.8)	-	1.375 (34.9)	2.950 (74.9)	1	1000	B30-R6000
Fig. 2	B33-18-483	B-483	Gloss White	3.000 (76.2)	1.000 (25.4)	-	1.125 (28.6)	3.200 (81.3)	1	1500	B30-R6000
Fig. 2	B33-19-483	B-483	Gloss White	3.000 (76.2)	2.000 (50.8)	-	2.125 (54.0)	3.200 (81.3)	1	500	B30-R6000
Fig. 2	B33-55-483	B-483	Gloss White	4.000 (101.6)	2.000 (50.8)	-	2.125 (54.0)	4.200 (106.7)	1	750	B30-R6000
Ultra-aggressive adhesive for highly textured surfaces (B-489 matte white):											
Fig. 1	B33-5-489	B-489	Matte White	1.000 (25.4)	0.500 (12.7)	1.075 (27.3)	0.600 (15.2)	3.350 (85.1)	3	5000	B30-R4300
Fig. 2	B33-17-489	B-489	Matte White	2.000 (50.8)	1.000 (25.4)	-	1.125 (28.6)	2.200 (55.9)	1	1500	B30-R4300
Fig. 2	B33-18-489	B-489	Matte White	3.000 (76.2)	1.000 (25.4)	-	1.125 (28.6)	3.200 (81.3)	1	1500	B30-R4300
Fig. 2	B33-19-489	B-489	Matte White	3.000 (76.2)	2.000 (50.8)	-	2.125 (54.0)	3.200 (81.3)	1	500	B30-R4300
Ultra-aggressive adhesive and pliable for conforming to angular surfaces (B-484A gloss white):											
Fig. 2	B33-125-484	B-484A	Gloss White	0.900 (22.9)	0.500 (12.7)	-	0.600 (15.2)	1.100 (27.9)	1	1500	B30-R6000
Fig. 1	B33-5-484	B-484A	Gloss White	1.000 (25.4)	0.500 (12.7)	1.075 (27.3)	0.600 (15.2)	3.350 (85.1)	3	5000	B30-R6000
Fig. 2	B33-136-484	B-484A	Gloss White	1.500 (38.1)	0.750 (19.1)	-	0.875 (22.2)	1.700 (43.2)	1	1500	B30-R6000
Fig. 2	B33-17-484	B-484A	Gloss White	2.000 (50.8)	1.000 (25.4)	-	1.125 (28.6)	2.200 (55.9)	1	1500	B30-R6000
Fig. 2	B33-18-484	B-484A	Gloss White	3.000 (76.2)	1.000 (25.4)	-	1.125 (28.6)	3.200 (81.3)	1	1500	B30-R6000
Fig. 2	B33-19-484	B-484A	Gloss White	3.000 (76.2)	2.000 (50.8)	-	2.125 (54.0)	3.200 (81.3)	1	500	B30-R6000

All part numbers above are compatible with BradyPrinter i3300 and BBP®33. Parts may also be compatible with BradyPrinter S3000, BradyPrinter S3100, BBP®30, BBP®31, BBP®35 and BBP®37 printers. Visit BradyID.com to confirm compatibility.

Metallized Polyester Labels (B-428, B-434, B-435, B-438, B-486 and B-565)

- For product labeling, asset tracking and general industrial ID
- Ideal for serial number plates and rating plates with name-plate quality and metal-looking finish

B-428: Service temp: -40°F to 293°F
B-434: Service temp: -40°F to 194°F
B-435: Service temp: -40°F to 194°F
B-438: Service temp: -40°F to 104°F
B-486: Service temp: -40°F to 248°F
B-565: Service temp: -40°F to 240°F

Agency approvals:   
 Agency approvals:   
 Agency approvals:   
 Agency approvals:   
 Agency approvals:   

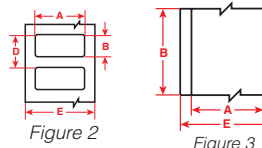
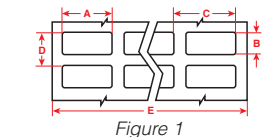

Figure 3



Diagram	Catalog #	B#	Color	Label Width A Inch (mm)	Label Height B Inch (mm)	Horiz. Repeat C Inch (mm)	Vert. Repeat D Inch (mm)	Web Width E Inch (mm)	Labels Per Row	Labels Per Roll	Rec. Ribbon
Standard adhesive for smooth surfaces (B-428 matte):											
Fig. 1	B33-5-428	B-428	Matte Silver	1.000 (25.4)	0.500 (12.7)	1.075 (27.3)	0.600 (15.2)	3.350 (85.1)	3	5000	B30-R4300
Fig. 2	B33-53-428	B-428	Matte Silver	2.000 (50.8)	0.500 (12.7)	-	0.600 (15.2)	2.200 (55.9)	1	2500	B30-R4300
Fig. 2	B33-17-428	B-428	Matte Silver	2.000 (50.8)	1.000 (25.4)	-	1.125 (28.6)	2.200 (55.9)	1	1500	B30-R4300
Fig. 2	B33-18-428	B-428	Matte Silver	3.000 (76.2)	1.000 (25.4)	-	1.125 (28.6)	3.200 (81.3)	1	1500	B30-R4300
Fig. 2	B33-19-428	B-428	Matte Silver	3.000 (76.2)	2.000 (50.8)	-	2.125 (54.0)	3.200 (81.3)	1	500	B30-R4300
Fig. 3	B33C-3000-428	B-428	Matte Silver	3.000 (76.2)	85 ft. (25.9m)	-	-	3.400 (86.4)	1 roll (cont.)		B30-R4300
Standard adhesive for smooth surfaces (B-565 matte):											
Fig. 3	B30C-1125-565-SL	B-565	Matte Silver	1.125 (28.6)	100 ft. (30.5m)	-	-	1.375 (34.9)	1 roll (cont.)		B30-R4300
Fig. 3	B30C-2250-565-SL	B-565	Matte Silver	2.250 (57.5)	100 ft. (30.5m)	-	-	2.500 (63.5)	1 roll (cont.)		B30-R4300
Fig. 3	B30C-4000-565-SL	B-565	Matte Silver	4.000 (101.6)	100 ft. (30.5m)	-	-	4.200 (106.7)	1 roll (cont.)		B30-R4300
Standard adhesive for smooth surfaces (B-435 gloss):											
Fig. 2	B33-18-435	B-435	Gloss Silver	3.000 (76.2)	1.000 (25.4)	-	1.125 (28.6)	3.200 (81.3)	1	1500	B30-R6000
Fig. 2	B33-19-435	B-435	Gloss Silver	3.000 (76.2)	2.000 (50.8)	-	2.125 (54.0)	3.200 (81.3)	1	500	B30-R6000
Fig. 2	B33-55-435	B-435	Gloss Silver	4.000 (101.6)	2.000 (50.8)	-	2.125 (54.0)	4.200 (106.7)	1	750	B30-R6000
Stronger adhesive for rougher surfaces (B-434 gloss):											
Fig. 1	B33-5-434	B-434	Gloss Silver	1.000 (25.4)	0.500 (12.7)	1.075 (27.3)	0.600 (15.2)	3.350 (85.1)	3	5000	B30-R6000
Fig. 2	B33-136-434	B-434	Gloss Silver	1.500 (38.1)	0.750 (19.1)	-	0.875 (22.2)	1.700 (43.2)	1	1500	B30-R6000
Fig. 2	B33-17-434	B-434	Gloss Silver	2.000 (50.8)	1.000 (25.4)	-	1.125 (28.6)	2.200 (55.9)	1	1500	B30-R6000
Fig. 2	B33-18-434	B-434	Gloss Silver	3.000 (76.2)	1.000 (25.4)	-	1.125 (28.6)	3.200 (81.3)	1	1500	B30-R6000
Fig. 2	B33-19-434	B-434	Gloss Silver	3.000 (76.2)	2.000 (50.8)	-	2.125 (54.0)	3.200 (81.3)	1	500	B30-R6000
Fig. 2	B33-55-434	B-434	Gloss Silver	4.000 (101.6)	2.000 (50.8)	-	2.125 (54.0)	4.200 (106.7)	1	750	B30-R6000
Ultra-aggressive adhesive for highly textured, powder coated and low surface energy surfaces (B-486 matte):											
Fig. 2	B33-59-486	B-486	Matte Silver	1.000 (25.4)	0.500 (12.7)	-	0.600 (15.2)	1.200 (30.5)	1	2500	B30-R4300
Fig. 1	B33-5-486	B-486	Matte Silver	1.000 (25.4)	0.500 (12.7)	1.075 (27.3)	0.600 (15.2)	3.350 (85.1)	3	5000	B30-R4300
Fig. 2	B33-53-486	B-486	Matte Silver	2.000 (50.8)	0.500 (12.7)	-	0.600 (15.2)	2.200 (55.9)	1	2500	B30-R4300
Fig. 2	B33-17-486	B-486	Matte Silver	2.000 (50.8)	1.000 (25.4)	-	1.125 (28.6)	2.200 (55.9)	1	1300	B30-R4300
Fig. 2	B33-7-486	B-486	Matte Silver	2.750 (69.9)	1.250 (31.8)	-	1.375 (34.9)	2.950 (74.9)	1	1000	B30-R4300
Fig. 2	B33-18-486	B-486	Matte Silver	3.000 (76.2)	1.000 (25.4)	-	1.125 (28.6)	3.200 (81.3)	1	1300	B30-R4300
Fig. 2	B33-19-486	B-486	Matte Silver	3.000 (76.2)	2.000 (50.8)	-	2.125 (54.0)	3.200 (81.3)	1	500	B30-R4300
Fig. 2	B33-76-486	B-486	Matte Silver	4.000 (101.6)	3.000 (76.2)	-	3.125 (79.4)	4.200 (106.7)	1	500	B30-R4300
Fig. 2	B33-161-486	B-486	Matte Silver	4.000 (101.6)	4.000 (101.6)	-	4.125 (104.8)	4.200 (106.7)	1	250	B30-R4300

Tamper-Evident Asset ID Labels (B-438)

- Leaves checkerboard footprint on surface and on label if removed to prevent re-use

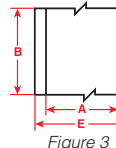
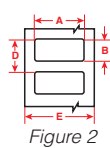



Diagram	Catalog #	B#	Color	Label Width A Inch (mm)	Label Height B Inch (mm)	Vert. Repeat D Inch (mm)	Web Width E Inch (mm)	Labels Per Row	Labels Per Roll	Rec. Ribbon
Fig. 2	B30-17-438	B-438	Matte Silver	2.000 (50.8)	1.000 (25.4)	2.500 (63.5)	1.125 (28.6)	1	1225	B30-R4300
Fig. 2	B30-18-438	B-438	Matte Silver	3.000 (76.2)	1.000 (25.4)	3.250 (82.6)	1.250 (31.8)	1	1225	B30-R4300
Fig. 2	B30-222-438	B-438	Matte Silver	3.000 (76.2)	2.000 (50.8)	3.250 (82.6)	2.250 (57.2)	1	650	B30-R4300
Fig. 3	B30C-3000-438-SL	B-438	Matte Silver	3.000 (76.2)	100 ft. (30.5m)	-	3.250 (82.6)	1 roll (cont.)		B30-R4300

All part numbers above are compatible with BradyPrinter i3300 and BBP®33. Parts may also be compatible with BradyPrinter S3000, BradyPrinter S3100, BBP®30, BBP®31, BBP®35 and BBP®37 printers. Visit BradyID.com to confirm compatibility.

Standard Polyimide Labels (B-724 and B-727)

- Top- or bottom-side component ID or board ID labels that withstand the various processes, fluxes and cleaning solvents encountered in the manufacture of printed circuit boards

B-727: Service temp: -94°F to 212°F (short burst max temp: 80 sec at 572°F, 5 min at 500°F, 2 hrs at 338°F)
Agency approvals:  **RoHS**

B-724: Service temp: -94°F to 518°F (short burst max temp: 80 sec at 626°F, 5 min at 536°F)
Agency approvals: **RoHS**

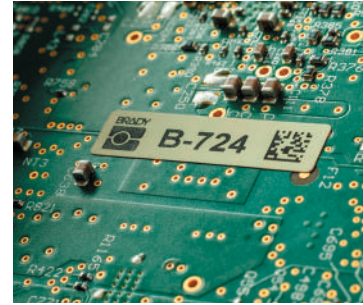
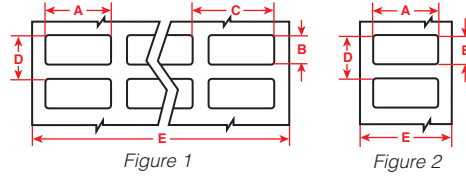

Diagram	Catalog #	B#	Color	Label Width A Inch (mm)	Label Height B Inch (mm)	Horiz. Repeat C Inch (mm)	Vert. Repeat D Inch (mm)	Web Width E Inch (mm)	Labels Per Row	Labels Per Roll	Rec. Ribbon
Standard temperature (B-727 gloss white):											
Fig. 1	B33-11-727	B-727	Gloss White	0.250 (6.35)	0.250 (6.4)	0.250 (6.4)	0.375 (9.5)	3.200 (81.3)	12	5000	B30-R6000
Fig. 1	B33-38-727	B-727	Gloss White	0.375 (9.5)	0.375 (9.5)	0.438 (11.1)	0.475 (12.1)	3.200 (81.3)	9	5000	B30-R6000
Fig. 1	B33-149-727	B-727	Gloss White	0.500 (12.7)	0.500 (12.7)	0.600 (15.2)	0.600 (15.2)	2.500 (63.5)	4	5000	B30-R6000
Fig. 1	B33-1-727	B-727	Gloss White	0.750 (19.1)	0.250 (6.4)	0.800 (20.3)	0.350 (8.9)	3.350 (85.1)	4	5000	B30-R6000
Fig. 2	B33-49-727	B-727	Gloss White	0.900 (22.9)	0.250 (6.4)	-	0.350 (8.9)	1.100 (27.9)	1	5000	B30-R6000
Fig. 1	B33-2-727	B-727	Gloss White	0.900 (22.9)	0.250 (6.4)	1.125 (28.6)	0.350 (8.9)	3.350 (85.1)	3	5000	B30-R6000
Fig. 2	B33-103-727	B-727	Gloss White	1.000 (25.4)	0.250 (6.4)	-	0.350 (8.9)	1.200 (30.5)	1	5000	B30-R6000
Fig. 2	B33-58-727	B-727	Gloss White	1.000 (25.4)	0.375 (9.5)	-	0.475 (12.1)	1.200 (30.5)	1	4000	B30-R6000
Fig. 2	B33-59-727	B-727	Gloss White	1.000 (25.4)	0.500 (12.7)	-	0.600 (15.2)	1.200 (30.5)	1	2500	B30-R6000
Fig. 2	B33-43-727	B-727	Gloss White	1.250 (31.8)	0.250 (6.4)	-	0.350 (8.9)	1.450 (36.8)	1	5000	B30-R6000
Fig. 2	B33-44-727	B-727	Gloss White	1.375 (34.9)	0.250 (6.4)	-	0.350 (8.9)	1.600 (40.6)	1	5000	B30-R6000
Fig. 2	B33-45-727	B-727	Gloss White	1.500 (38.1)	0.250 (6.4)	-	0.350 (8.9)	1.700 (43.2)	1	5000	B30-R6000
Fig. 2	B33-72-727	B-727	Gloss White	1.750 (44.5)	0.250 (6.4)	-	0.350 (8.9)	1.950 (49.5)	1	5000	B30-R6000
Extremely high temperature (B-724 matte amber):											
Fig. 1	B33-149-724	B-724	Matte Amber	0.500 (12.7)	0.500 (12.7)	0.600 (15.2)	0.600 (15.2)	2.500 (63.5)	4	5000	B30-R4300
Fig. 2	B33-46-724	B-724	Matte Amber	0.750 (19.1)	0.250 (6.4)	-	0.350 (8.9)	0.950 (24.1)	1	5000	B30-R4300
Fig. 1	B33-1-724	B-724	Matte Amber	0.750 (19.1)	0.250 (6.4)	0.800 (20.3)	0.350 (8.9)	3.350 (85.1)	4	5000	B30-R4300
Fig. 1	B33-2-724	B-724	Matte Amber	0.900 (22.9)	0.250 (6.4)	1.125 (28.6)	0.350 (8.9)	3.350 (85.1)	3	5000	B30-R4300
Fig. 2	B33-43-724	B-724	Matte Amber	1.250 (31.8)	0.250 (6.4)	-	0.350 (8.9)	1.450 (36.8)	1	5000	B30-R4300
Fig. 1	B33-4-724	B-724	Matte Amber	1.500 (38.1)	0.250 (6.4)	-	0.350 (8.9)	3.350 (85.1)	2	5000	B30-R4300

Paper Labels (B-424)

- Economical choice for light duty general ID
- White finish and matte topcoat
- Excellent contrast and smear resistance for barcode printing

Service temp: -40°F to 124°F Agency approvals: **RoHS**

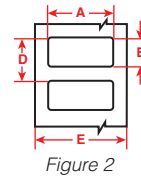

Diagram	Catalog #	B#	Color	Label Width A Inch (mm)	Label Height B Inch (mm)	Horiz. Repeat C Inch (mm)	Vert. Repeat D Inch (mm)	Web Width E Inch (mm)	Labels Per Row	Labels Per Roll	Rec. Ribbon
Fig. 2	B33-53-424	B-424	White	2.000 (50.8)	0.500 (12.7)	-	0.600 (15.2)	2.200 (55.9)	1	2500	B30-R4300
Fig. 2	B33-17-424	B-424	White	2.000 (50.8)	1.000 (25.4)	1.125 (28.6)	2.200 (55.9)	-	1	1500	B30-R4300
Fig. 2	B33-7-424	B-424	White	2.750 (69.9)	1.250 (31.8)	-	1.375 (34.9)	2.950 (74.9)	1	1000	B30-R4300
Fig. 2	B33-18-424	B-424	White	3.000 (76.2)	1.000 (25.4)	1.125 (28.6)	3.200 (81.3)	-	1	1500	B30-R4300
Fig. 2	B33-19-424	B-424	White	3.000 (76.2)	2.000 (50.8)	2.125 (54.0)	3.200 (81.3)	-	1	500	B30-R4300
Fig. 2	B33-20-424	B-424	White	3.000 (76.2)	5.000 (127)	-	5.125 (130.2)	3.200 (81.3)	1	250	B30-R4300
Fig. 2	B33-55-424	B-424	White	4.000 (101.6)	2.000 (50.8)	-	2.125 (54.0)	4.200 (106.7)	1	750	B30-R4300
Fig. 2	B33-25-424	B-424	White	4.000 (101.6)	6.000 (152.4)	6.125 (155.6)	4.200 (106.7)	-	1	350	B30-R4300

All part numbers above are compatible with BradyPrinter i3300 and BBP®33. Parts may also be compatible with BradyPrinter S3000, BradyPrinter S3100, BBP®30, BBP®31, BBP®35 and BBP®37 printers. Visit BradyID.com to confirm compatibility.

Static Dissipative Polyimide Labels (B-717, B-718 and B-719)

- Circuit board and electronic component ID with static dissipative adhesive and release liner with surface resistivity values recommended for dissipative ESD packaging
- Complies with EIA-541 packaging material standards for ESD sensitive items
- For top- or bottom-side component or board identification

All: Service temp: -94°F to 212°F (short burst max temp:

80 sec at 572°F, 5 min at 500°F, 2 hrs at 338°F)

Agency approvals:  

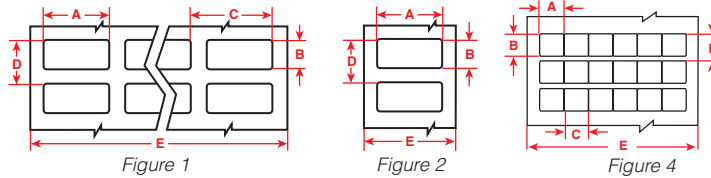
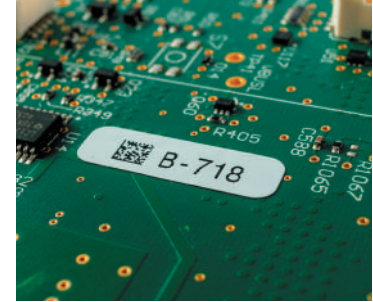







Diagram	Catalog #	B#	Color	Label Width A Inch (mm)	Label Height B Inch (mm)	Horiz. Repeat C Inch (mm)	Vert. Repeat D Inch (mm)	Web Width E Inch (mm)	Labels Per Row	Labels Per Roll	Rec. Ribbon
Standard thickness (B-717 gloss white):											
Fig. 2	* B33-46-717	B-717	Gloss White	0.750 (19.1)	0.250 (6.4)	-	0.350 (8.9)	0.950 (24.1)	1	5000	B30-R6000
Fig. 2	* B33-103-717	B-717	Gloss White	1.000 (25.4)	0.250 (6.4)	-	0.350 (8.9)	1.200 (30.5)	1	5000	B30-R6000
Fig. 2	* B33-43-717	B-717	Gloss White	1.250 (31.8)	0.250 (6.4)	-	0.350 (8.9)	1.450 (36.8)	1	5000	B30-R6000
Fig. 2	* B33-45-717	B-717	Gloss White	1.500 (38.1)	0.250 (6.4)	-	0.350 (8.9)	1.700 (43.2)	1	5000	B30-R6000
Low profile label (B-718 gloss white):											
Fig. 4	* B33-11-718	B-718	Gloss White	0.250 (6.4)	0.250 (6.4)	0.250 (6.4)	0.375 (9.5)	3.200 (81.3)	12	1500	B30-R6000
Fig. 1	* B33-38-718	B-718	Gloss White	0.375 (9.5)	0.375 (9.5)	0.438 (11.1)	0.475 (12.1)	3.200 (81.3)	9	5000	B30-R6000
Fig. 1	* B33-149-718	B-718	Gloss White	0.500 (12.7)	0.500 (12.7)	0.600 (15.2)	0.600 (15.2)	2.500 (63.5)	4	5000	B30-R6000
Fig. 1	* B33-1-718	B-718	Gloss White	0.750 (19.1)	0.250 (6.4)	0.800 (20.3)	0.350 (8.9)	3.350 (85.1)	4	5000	B30-R6000
Fig. 2	* B33-46-718	B-718	Gloss White	0.750 (19.1)	0.250 (6.4)	-	0.350 (8.9)	0.950 (24.1)	1	5000	B30-R6000
Fig. 2	* B33-49-718	B-718	Gloss White	0.900 (22.9)	0.250 (6.4)	-	0.350 (8.9)	1.100 (27.9)	1	5000	B30-R6000
Fig. 2	* B33-43-718	B-718	Gloss White	1.250 (31.8)	0.250 (6.4)	-	0.350 (8.9)	1.450 (36.8)	1	5000	B30-R6000
Fig. 2	* B33-45-718	B-718	Gloss White	1.500 (38.1)	0.250 (6.4)	-	0.350 (8.9)	1.700 (43.2)	1	5000	B30-R6000
Fig. 2	* B33-72-718	B-718	Gloss White	1.750 (44.5)	0.250 (6.4)	-	0.350 (8.9)	1.950 (49.5)	1	5000	B30-R6000
Low profile label to prevent sticking of solder balls (B-719 matte white):											
Fig. 1	* B33-38-719	B-719	Matte White	0.375 (9.5)	0.375 (9.5)	0.438 (11.1)	0.475 (12.1)	3.200 (81.3)	9	5000	B30-R6000
Fig. 2	* B33-46-719	B-719	Matte White	0.750 (19.1)	0.250 (6.4)	-	0.350 (8.9)	0.950 (24.1)	1	5000	B30-R6000
Fig. 1	* B33-2-719	B-719	Matte White	0.900 (22.9)	0.250 (6.4)	1.125 (28.6)	0.350 (8.9)	3.350 (85.1)	3	5000	B30-R6000
Fig. 2	* B33-43-719	B-719	Matte White	1.250 (31.8)	0.250 (6.4)	-	0.350 (8.9)	1.450 (36.8)	1	5000	B30-R6000

*  **WARNING:** Cancer www.P65Warnings.ca.gov

Polypropylene Labels (B-425)

- General labeling material for indoor use
- Outstanding chemical and solvent resistance and print performance
- Not recommended for prolonged outdoor use

Service temp: -94°F to 212°F

Agency approvals:    

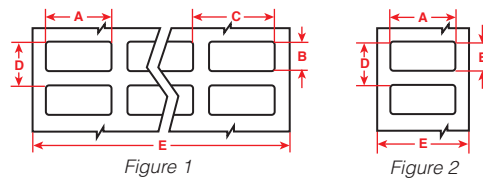

Diagram	Catalog #	B#	Color	Label Width A Inch (mm)	Label Height B Inch (mm)	Horiz. Repeat C Inch (mm)	Vert. Repeat D Inch (mm)	Web Width E Inch (mm)	Labels Per Row	Labels Per Roll	Rec. Ribbon
Fig. 1	B33-5-425	B-425	White	1.000 (25.4)	0.500 (12.7)	1.075 (27.3)	0.600 (15.2)	3.350 (85.1)	3	5000	B30-R4300
Fig. 2	B33-17-425	B-425	White	2.000 (50.8)	1.000 (25.4)	-	1.125 (28.6)	2.200 (55.9)	1	1500	B30-R4300
Fig. 2	B33-18-425	B-425	White	3.000 (76.2)	1.000 (25.4)	-	1.125 (28.6)	3.200 (81.3)	1	1500	B30-R4300
Fig. 2	B33-19-425	B-425	White	3.000 (76.2)	2.000 (50.8)	-	2.125 (54.0)	3.200 (81.3)	1	500	B30-R4300

All part numbers above are compatible with BradyPrinter i3300 and BBP®33. Parts may also be compatible with BradyPrinter S3000, BradyPrinter S3100, BBP®30, BBP®31, BBP®35 and BBP®37 printers. Visit BradyID.com to confirm compatibility.

Raised Profile Labels – Engraved Plate Substitutes – Push Button Style (B-593)

Costs up to 80% less than engraved legend plates

- High gloss, polyester label with thick raised profile and ultra-aggressive adhesive (0.70 mm thick)
- High-performance, low-cost substitute to engraved plates
- 10-year outdoor durability rating
- On-demand labeling: labels print out in fewer than 4 seconds
- 5 push button sizes (including keyed and non-keyed 22.5 mm and 30.5 mm hole dia. keyed)

Service temp: -4°F to 212°F Application temp: 50°F to 212°F

Average outdoor durability: Up to 10 years

Agency approvals:   

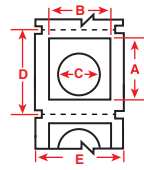

Figure 18b
(Without key hole)

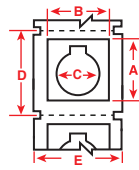

Figure 18a



Diagram	Catalog #	B#	Color	Label Height A Inch (mm)	Label Width B Inch (mm)	Hole Diameter C Inch (mm)	Vert. Repeat D Inch (mm)	Web Width E Inch (mm)	Labels Per Row	Labels Per Roll	Rec. Ribbon
Fig. 18a	B30EP-167-593-WT	B-593	White	1.500 (38.1)	1.200 (30.5)	0.885 (22.5)	1.750 (44.5)	2.500 (63.5)	1	200	B30-R6000
Fig. 18b	B30EP-167U-593-WT	B-593	White	1.500 (38.1)	1.200 (30.5)	0.885 (22.5)	1.750 (44.5)	2.500 (63.5)	1	200	B30-R6000
Fig. 18a	B30EP-169-593-WT	B-593	White	1.800 (45.7)	1.800 (45.7)	1.200 (30.5)	2.000 (50.8)	2.500 (63.5)	1	190	B30-R6000
Fig. 18a	B30EP-168-593-WT	B-593	White	1.900 (48.3)	1.200 (30.5)	0.885 (22.5)	2.125 (54.0)	2.500 (63.5)	1	180	B30-R6000
Fig. 18a	B30EP-170-593-WT	B-593	White	2.400 (60.9)	2.400 (60.9)	1.200 (30.5)	2.625 (66.7)	3.250 (82.6)	1	145	B30-R6000
Fig. 18a	B30EP-167-593-YL	B-593	Yellow	1.500 (38.1)	1.200 (30.5)	0.885 (22.5)	1.750 (44.5)	2.500 (63.5)	1	200	B30-R6000
Fig. 18b	B30EP-167U-593-YL	B-593	Yellow	1.500 (38.1)	1.200 (30.5)	0.885 (22.5)	1.750 (44.5)	2.500 (63.5)	1	200	B30-R6000
Fig. 18a	B30EP-169-593-YL	B-593	Yellow	1.800 (45.7)	1.800 (45.7)	1.200 (30.5)	2.000 (50.8)	2.500 (63.5)	1	190	B30-R6000
Fig. 18a	B30EP-168-593-YL	B-593	Yellow	1.900 (48.3)	1.200 (30.5)	0.885 (22.5)	2.125 (54.0)	2.500 (63.5)	1	180	B30-R6000
Fig. 18a	B30EP-170-593-YL	B-593	Yellow	2.400 (60.9)	2.400 (60.9)	1.200 (30.5)	2.625 (66.7)	3.250 (82.6)	1	145	B30-R6000
Fig. 18a	B30EP-167-593-BK	B-593	Black	1.500 (38.1)	1.200 (30.5)	0.885 (22.5)	1.750 (44.5)	2.500 (63.5)	1	200	B30-R4400-WT
Fig. 18b	B30EP-167U-593-BK	B-593	Black	1.500 (38.1)	1.200 (30.5)	0.885 (22.5)	1.750 (44.5)	2.500 (63.5)	1	200	B30-R4400-WT
Fig. 18a	B30EP-169-593-BK	B-593	Black	1.800 (45.7)	1.800 (45.7)	1.200 (30.5)	2.000 (50.8)	2.500 (63.5)	1	190	B30-R4400-WT
Fig. 18a	B30EP-168-593-BK	B-593	Black	1.900 (48.3)	1.200 (30.5)	0.885 (22.5)	2.125 (54.0)	2.500 (63.5)	1	180	B30-R4400-WT
Fig. 18a	B30EP-170-593-BK	B-593	Black	2.400 (60.9)	2.400 (60.9)	1.200 (30.5)	2.625 (66.7)	3.250 (82.6)	1	145	B30-R4400-WT
Fig. 18a	B30EP-167-593-GN	B-593	Green	1.500 (38.1)	1.200 (30.5)	0.885 (22.5)	1.750 (44.5)	2.500 (63.5)	1	200	B30-R4400-WT
Fig. 18b	B30EP-167U-593-GN	B-593	Green	1.500 (38.1)	1.200 (30.5)	0.885 (22.5)	1.750 (44.5)	2.500 (63.5)	1	200	B30-R4400-WT
Fig. 18a	B30EP-169-593-GN	B-593	Green	1.800 (45.7)	1.800 (45.7)	1.200 (30.5)	2.000 (50.8)	2.500 (63.5)	1	190	B30-R4400-WT
Fig. 18a	B30EP-168-593-GN	B-593	Green	1.900 (48.3)	1.200 (30.5)	0.885 (22.5)	2.125 (54.0)	2.500 (63.5)	1	180	B30-R4400-WT
Fig. 18a	B30EP-170-593-GN	B-593	Green	2.400 (60.9)	2.400 (60.9)	1.200 (30.5)	2.625 (66.7)	3.250 (82.6)	1	145	B30-R4400-WT
Fig. 18a	B30EP-167-593-RD	B-593	Red	1.500 (38.1)	1.200 (30.5)	0.885 (22.5)	1.750 (44.5)	2.500 (63.5)	1	200	B30-R4400-WT
Fig. 18b	B30EP-167U-593-RD	B-593	Red	1.500 (38.1)	1.200 (30.5)	0.885 (22.5)	1.750 (44.5)	2.500 (63.5)	1	200	B30-R4400-WT
Fig. 18a	B30EP-169-593-RD	B-593	Red	1.800 (45.7)	1.800 (45.7)	1.200 (30.5)	2.000 (50.8)	2.500 (63.5)	1	190	B30-R4400-WT
Fig. 18a	B30EP-168-593-RD	B-593	Red	1.900 (48.3)	1.200 (30.5)	0.885 (22.5)	2.125 (54.0)	2.500 (63.5)	1	180	B30-R4400-WT
Fig. 18a	B30EP-170-593-RD	B-593	Red	2.400 (60.9)	2.400 (60.9)	1.200 (30.5)	2.625 (66.7)	3.250 (82.6)	1	145	B30-R4400-WT

U.S. Patent Nos. US8475914B2; US9005729B2.

All part numbers above are compatible with BradyPrinter i3300 and BBP®33. Parts may also be compatible with BradyPrinter S3000, BradyPrinter S3100, BBP®30, BBP®31, BBP®35 and BBP®37 printers. Visit BradyID.com to confirm compatibility.

Raised Profile Labels – Engraved Plate Substitutes – Rectangular Style (B-593)

Costs up to 80% less than engraved legend plates

- High gloss, polyester label with thick raised profile and ultra-aggressive adhesive (0.70 mm thick)
- Ideal for inside-panel backer board labels and front-of-enclosure labeling
- Costs up to 80% less than engraved plates and prints out in about 4 seconds
- 10-year outdoor durability rating

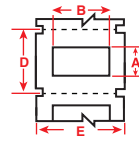
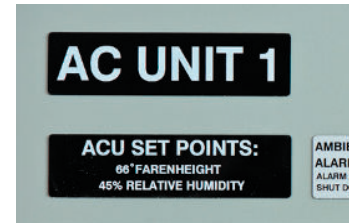

Figure 18c



Service temp: -4°F to 212°F Application temp: 50°F to 212°F
Average outdoor durability: Up to 10 years
Agency approvals:

Diagram	Catalog #	B#	Color	Label Height A Inch (mm)	Label Width B Inch (mm)	Vert. Repeat D Inch (mm)	Web Width E Inch (mm)	Labels Per Row	Labels Per Roll	Rec. Ribbon
Fig. 18c	B30EP-171-593-WT	B-593	White	0.490 (12.5)	1.060 (26.9)	0.750 (19.1)	1.375 (34.9)	1	500	B30-R6000
Fig. 18c	B30EP-172-593-WT	B-593	White	0.590 (15.0)	1.770 (45.0)	0.850 (21.6)	2.500 (63.5)	1	450	B30-R6000
Fig. 18c	B30EP-175-593-WT	B-593	White	0.750 (19.1)	3.000 (76.2)	1.000 (25.4)	3.250 (82.6)	1	375	B30-R6000
Fig. 18c	B30EP-173-593-WT	B-593	White	1.000 (25.4)	2.000 (50.8)	1.250 (31.8)	2.500 (63.5)	1	300	B30-R6000
Fig. 18c	B30EP-174-593-WT	B-593	White	1.000 (25.4)	4.000 (101.6)	1.250 (31.8)	4.250 (108.0)	1	300	B30-R6000
Fig. 18c	B30EP-176-593-WT	B-593	White	1.000 (25.4)	3.000 (76.2)	1.250 (31.8)	3.250 (82.6)	1	300	B30-R6000
Fig. 18c	B30EP-177-593-WT	B-593	White	2.500 (63.5)	3.000 (76.2)	2.750 (69.9)	3.250 (82.6)	1	125	B30-R6000
Fig. 18c	B30EP-171-593-YL	B-593	Yellow	0.490 (12.5)	1.060 (26.9)	0.750 (19.1)	1.375 (34.9)	1	500	B30-R6000
Fig. 18c	B30EP-172-593-YL	B-593	Yellow	0.590 (15.0)	1.770 (45.0)	0.850 (21.6)	2.500 (63.5)	1	450	B30-R6000
Fig. 18c	B30EP-175-593-YL	B-593	Yellow	0.750 (19.1)	3.000 (76.2)	1.000 (25.4)	3.250 (82.6)	1	375	B30-R6000
Fig. 18c	B30EP-173-593-YL	B-593	Yellow	1.000 (25.4)	2.000 (50.8)	1.250 (31.8)	2.500 (63.5)	1	300	B30-R6000
Fig. 18c	B30EP-174-593-YL	B-593	Yellow	1.000 (25.4)	4.000 (101.6)	1.250 (31.8)	4.250 (108.0)	1	300	B30-R6000
Fig. 18c	B30EP-176-593-YL	B-593	Yellow	1.000 (25.4)	3.000 (76.2)	1.250 (31.8)	3.250 (82.6)	1	300	B30-R6000
Fig. 18c	B30EP-177-593-YL	B-593	Yellow	2.500 (63.5)	3.000 (76.2)	2.750 (69.9)	3.250 (82.6)	1	125	B30-R6000
Fig. 18c	B30EP-171-593-BK	B-593	Black	0.490 (12.5)	1.060 (26.9)	0.750 (19.1)	1.375 (34.9)	1	500	B30-R4400-WT
Fig. 18c	B30EP-172-593-BK	B-593	Black	0.590 (15.0)	1.770 (45.0)	0.850 (21.6)	2.500 (63.5)	1	450	B30-R4400-WT
Fig. 18c	B30EP-175-593-BK	B-593	Black	0.750 (19.1)	3.000 (76.2)	1.000 (25.4)	3.250 (82.6)	1	375	B30-R4400-WT
Fig. 18c	B30EP-173-593-BK	B-593	Black	1.000 (25.4)	2.000 (50.8)	1.250 (31.8)	2.500 (63.5)	1	300	B30-R4400-WT
Fig. 18c	B30EP-174-593-BK	B-593	Black	1.000 (25.4)	4.000 (101.6)	1.250 (31.8)	4.250 (108.0)	1	300	B30-R4400-WT
Fig. 18c	B30EP-176-593-BK	B-593	Black	1.000 (25.4)	3.000 (76.2)	1.250 (31.8)	3.250 (82.6)	1	300	B30-R4400-WT
Fig. 18c	B30EP-177-593-BK	B-593	Black	2.500 (63.5)	3.000 (76.2)	2.750 (69.9)	3.250 (82.6)	1	125	B30-R4400-WT
Fig. 18c	B30EP-171-593-GN	B-593	Green	0.490 (12.5)	1.060 (26.9)	0.750 (19.1)	1.375 (34.9)	1	500	B30-R4400-WT
Fig. 18c	B30EP-172-593-GN	B-593	Green	0.590 (15.0)	1.770 (45.0)	0.850 (21.6)	2.500 (63.5)	1	450	B30-R4400-WT
Fig. 18c	B30EP-175-593-GN	B-593	Green	0.750 (19.1)	3.000 (76.2)	1.000 (25.4)	3.250 (82.6)	1	375	B30-R4400-WT
Fig. 18c	B30EP-173-593-GN	B-593	Green	1.000 (25.4)	2.000 (50.8)	1.250 (31.8)	2.500 (63.5)	1	300	B30-R4400-WT
Fig. 18c	B30EP-174-593-GN	B-593	Green	1.000 (25.4)	4.000 (101.6)	1.250 (31.8)	4.250 (108.0)	1	300	B30-R4400-WT
Fig. 18c	B30EP-176-593-GN	B-593	Green	1.000 (25.4)	3.000 (76.2)	1.250 (31.8)	3.250 (82.6)	1	300	B30-R4400-WT
Fig. 18c	B30EP-177-593-GN	B-593	Green	2.500 (63.5)	3.000 (76.2)	2.750 (69.9)	3.250 (82.6)	1	125	B30-R4400-WT
Fig. 18c	B30EP-171-593-RD	B-593	Red	0.490 (12.5)	1.060 (26.9)	0.750 (19.1)	1.375 (34.9)	1	500	B30-R4400-WT
Fig. 18c	B30EP-172-593-RD	B-593	Red	0.590 (15.0)	1.770 (45.0)	0.850 (21.6)	2.500 (63.5)	1	450	B30-R4400-WT
Fig. 18c	B30EP-173-593-RD	B-593	Red	1.000 (25.4)	2.000 (50.8)	1.250 (31.8)	2.500 (63.5)	1	300	B30-R4400-WT
Fig. 18c	B30EP-174-593-RD	B-593	Red	1.000 (25.4)	4.000 (101.6)	1.250 (31.8)	4.250 (108.0)	1	300	B30-R4400-WT
Fig. 18c	B30EP-171-593-SL	B-593	Silver	0.490 (12.5)	1.060 (26.9)	0.750 (19.1)	1.375 (34.9)	1	500	B30-R6000
Fig. 18c	B30EP-172-593-SL	B-593	Silver	0.590 (15.0)	1.770 (45.0)	0.850 (21.6)	2.500 (63.5)	1	450	B30-R6000
Fig. 18c	B30EP-173-593-SL	B-593	Silver	1.000 (25.4)	2.000 (50.8)	1.250 (31.8)	2.500 (63.5)	1	300	B30-R6000
Fig. 18c	B30EP-174-593-SL	B-593	Silver	1.000 (25.4)	4.000 (101.6)	1.250 (31.8)	4.250 (108.0)	1	300	B30-R6000

U.S. Patent Nos. US8475914B2; US9005729B2.

All part numbers above are compatible with BradyPrinter i3300 and BBP®33. Parts may also be compatible with BradyPrinter S3000, BradyPrinter S3100, BBP®30, BBP®31, BBP®35 and BBP®37 printers. Visit BradyID.com to confirm compatibility.

Panel ID Labels (B-483, B-484A, B-499, B-593 and B-595)

- Various sizes in several durable material types
- Also ideal for marking backer board, DIN rail, relays, PLCs, switches, solenoids, drive motors and other components inside panels
- All recommended materials are flexible and have high-tack adhesives for adhesion to wide variety of surfaces and components

B-483: Service temp: -40°F to 248°F Agency approvals:
B-484A: Service temp: -40°F to 240°F Agency approvals:
B-499: Service temp: -40°F to 193°F Agency approvals:
B-593: Service temp: -4°F to 212°F
B-595: Service temp: -40°F to 180°F Agency approvals:
 8-10 years average outdoor durability

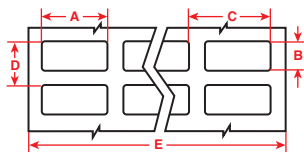

Figure 1

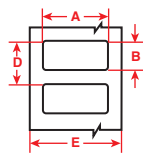

Figure 2

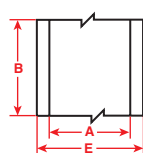

Figure 3

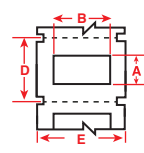

Figure 18c

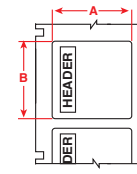

Figure 70

Diagram	Catalog #	B#	Color	Label Width A Inch (mm)	Label Height B Inch (mm)	Horiz. Repeat C Inch (mm)	Vert. Repeat D Inch (mm)	Web Width E Inch (mm)	Labels Per Row	Labels Per Roll	Rec. Ribbon
Nylon Cloth - Permanent adhesive (B-499):											
Fig. 1	B33-68-499	B-499	White	0.500 (12.7)	0.750 (19.1)	0.600 (15.2)	0.875 (22.2)	2.500 (63.5)	4	1500	B30-R6000
Fig. 1	B33-165-499	B-499	White	0.800 (20.3)	1.437 (36.5)	0.900 (22.9)	1.562 (39.7)	3.700 (94.0)	4	2500	B30-R6000
Fig. 2	B33-125-499	B-499	White	0.900 (22.9)	0.500 (12.7)	-	-	-	1	1500	B30-R6000
Fig. 1	B33-126-499	B-499	White	0.900 (22.9)	0.500 (12.7)	-	-	-	2	1500	B30-R6000
Fig. 2	B33-163-499	B-499	White	1.000 (25.4)	0.375 (9.5)	-	-	-	1	1500	B30-R6000
Fig. 1	B33-152-499	B-499	White	1.000 (25.4)	0.375 (9.5)	-	-	-	2	1500	B30-R6000
Fig. 2	B33-136-499	B-499	White	1.500 (38.1)	0.750 (19.1)	-	0.875 (22.2)	1.770 (45.0)	1	1500	B30-R6000
Fig. 2	B33-137-499	B-499	White	2.000 (50.8)	1.000 (25.4)	-	1.125 (28.6)	2.200 (55.9)	1	1100	B30-R6000
Fig. 2	B33-125-499	B-499	White	2.000 (50.8)	0.250 (6.4)	-	-	-	1	1500	B30-R6000
Polyester - Ultra-aggressive adhesive for highly textured and low surface energy surfaces (B-483):											
Fig. 1	B33-149-483	B-483	White	0.500 (12.7)	0.500 (12.7)	0.600 (15.2)	0.600 (15.2)	2.500 (63.5)	4	5000	B30-R6000
Fig. 1	B33-5-483	B-483	White	1.000 (25.4)	0.500 (12.7)	1.075 (27.3)	0.600 (15.2)	3.350 (85.1)	3	5000	B30-R6000
Fig. 2	B33-17-483	B-483	White	2.000 (50.8)	1.000 (25.4)	-	1.125 (28.6)	2.200 (55.9)	1	1500	B30-R6000
Fig. 2	B33-7-483	B-483	White	2.750 (69.9)	1.250 (31.8)	-	1.375 (34.9)	2.950 (74.9)	1	1000	B30-R6000
Fig. 2	B33-18-483	B-483	White	3.000 (76.2)	1.000 (25.4)	-	1.125 (28.6)	3.200 (81.3)	1	1500	B30-R6000
Fig. 2	B33-19-483	B-483	White	3.000 (76.2)	2.000 (50.8)	-	2.125 (54.0)	3.200 (81.3)	1	500	B30-R6000
Fig. 2	B33-55-483	B-483	White	4.000 (101.6)	2.000 (50.8)	-	2.125 (54.0)	4.200 (106.7)	1	750	B30-R6000
Polyester - Ultra-aggressive adhesive and pliable for conforming to angular surfaces (B-484A):											
Fig. 2	B33-125-484	B-484A	White	0.900 (22.9)	0.500 (12.7)	-	0.600 (15.2)	1.100 (27.9)	1	1500	B30-R6000
Fig. 1	B33-5-484	B-484A	White	1.000 (25.4)	0.500 (12.7)	1.075 (27.3)	0.600 (15.2)	3.350 (85.1)	3	5000	B30-R6000
Fig. 2	B33-136-484	B-484A	White	1.500 (38.1)	0.750 (19.1)	-	0.875 (22.2)	1.700 (43.2)	1	1500	B30-R6000
Fig. 2	B33-17-484	B-484A	White	2.000 (50.8)	1.000 (25.4)	-	1.125 (28.6)	2.200 (55.9)	1	1500	B30-R6000
Fig. 2	B33-18-484	B-484A	White	3.000 (76.2)	1.000 (25.4)	-	1.125 (28.6)	3.200 (81.3)	1	1500	B30-R6000
Fig. 2	B33-19-484	B-484A	White	3.000 (76.2)	2.000 (50.8)	-	2.125 (54.0)	3.200 (81.3)	1	500	B30-R6000
Raised Profile Polyester - Thick raised profile label with ultra-aggressive adhesive (B-593):											
Fig. 18c	B30EP-171-593-WT	B-593	White	0.490 (12.5)	1.060 (26.9)	-	0.750 (19.1)	1.375 (34.9)	1	500	B30-R6000
Fig. 18c	B30EP-171-593-BK	B-593	Black	0.490 (12.5)	1.060 (26.9)	-	0.750 (19.1)	1.375 (34.9)	1	500	B30-R6000
Pre-Printed Vinyl - Permanent adhesive, conformable; Indoor / outdoor grade (B-595):											
Fig. 70	B30-241-595-ANSIDA	B-595		2.250 (57.5)	3.000 (76.2)	-	-	-	1	300	B30-R10000
Fig. 70	B30-25-595-ANSIDA	B-595		4.000 (101.6)	6.000 (152.4)	-	-	-	1	175	B30-R10000
Fig. 70	B30-241-595-ANSIWA	B-595		2.250 (57.5)	3.000 (76.2)	-	-	-	1	300	B30-R10000
Fig. 70	B30-25-595-ANSIWA	B-595		4.000 (101.6)	6.000 (152.4)	-	-	-	1	175	B30-R10000

All part numbers above are compatible with BradyPrinter i3300 and BBP®33. Parts may also be compatible with BradyPrinter S3000, BradyPrinter S3100, BBP®30, BBP®31, BBP®35 and BBP®37 printers. Visit BradyID.com to confirm compatibility.

Self-Laminating Wire and Cable Labels (B-427)

- Brady's most popular wire marker!
- Features white printable area with clear "tail" that wraps around marker to protect text
- Superior resistance to abrasion, handling, solvents, water, oil and dirt
- Vinyl with permanent acrylic adhesive designed specifically for tightly curved surfaces

Service temp: -40°F to 158°F

Agency approvals:  

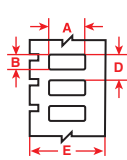
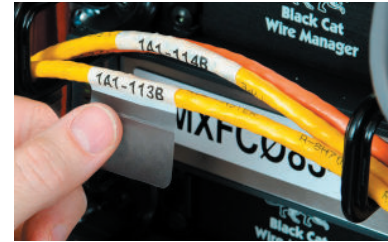

Figure 9a

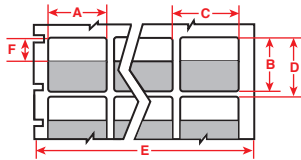

Figure 12

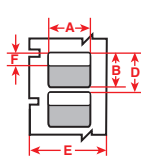

Figure 14

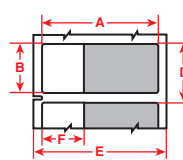

Figure 15

Diagram	Catalog #	B#	Color	Label Width A Inch (mm)	Label Height B Inch (mm)	Horiz. Repeat C Inch (mm)	Vert. Repeat D Inch (mm)	Web Width E Inch (mm)	Print Area Height F Inch (mm)	Labels Per Row	Labels Per Roll	Rec. Ribbon
Fig. 12	B33-80-427	B-427	White	0.500 (12.7)	0.750 (19.1)	0.600 (15.2)	0.950 (24.1)	2.500 (63.5)	0.375 (9.5)	4	2500	B30-R4300
Fig. 12	B33-113-427	B-427	White	0.500 (12.7)	1.000 (25.4)	0.600 (15.2)	0.950 (24.1)	2.500 (63.5)	0.375 (9.5)	4	2500	B30-R4300
Fig. 12	B33-8-427	B-427	White	0.500 (12.7)	1.437 (36.5)	0.662 (16.8)	1.625 (41.3)	3.350 (85.1)	0.500 (12.7)	5	5000	B30-R4300
Fig. 12	B33-56-427	B-427	White	0.750 (19.1)	0.937 (23.8)	0.800 (20.3)	1.125 (28.6)	3.350 (85.1)	0.375 (9.5)	4	5000	B30-R4300
Fig. 12	B33-73-427	B-427	White	0.750 (19.1)	1.750 (44.6)	0.800 (20.3)	1.875 (47.6)	3.350 (85.1)	0.500 (12.7)	4	3500	B30-R4300
Fig. 12	B33-74-427	B-427	White	0.800 (20.3)	1.437 (36.5)	0.800 (20.3)	1.625 (41.3)	3.400 (86.4)	0.500 (12.7)	4	4000	B30-R4300
Fig. 12	B33-115-427	B-427	White	1.000 (25.4)	0.750 (19.1)	1.100 (27.9)	0.875 (22.2)	2.300 (58.4)	0.375 (9.5)	2	2500	B30-R4300
Fig. 12	B33-116-427	B-427	White	1.000 (25.4)	1.000 (25.4)	1.100 (27.9)	1.125 (28.6)	2.300 (58.4)	0.375 (9.5)	2	2500	B30-R4300
Fig. 12	B33-9-427	B-427	White	1.000 (25.4)	1.437 (36.5)	1.075 (27.3)	1.625 (41.3)	3.350 (85.1)	0.500 (12.7)	3	2500	B30-R4300
Fig. 12	B33-75-427	B-427	White	1.000 (25.4)	2.250 (57.2)	1.100 (27.9)	2.375 (60.3)	2.300 (58.4)	0.750 (19.1)	2	1400	B30-R4300
Fig. 15	B33-131-427	B-427	White	1.000 (25.4)	2.625 (66.7)	-	1.125 (28.6)	2.825 (71.8)	1.000 (25.4)	1	1500	B30-R4300
Fig. 12	B33-10-427	B-427	White	1.000 (25.4)	3.750 (95.3)	1.075 (27.3)	4.000 (101.6)	3.350 (85.1)	1.000 (25.4)	3	1200	B30-R4300
Fig. 12	B33-81-427	B-427	White	1.000 (25.4)	6.000 (152.4)	1.100 (27.9)	6.187 (157.1)	2.300 (58.4)	1.500 (38.1)	2	500	B30-R4300
Fig. 9a	B33-135-427AW	B-427	White	1.500 (38.1)	0.750 (19.1)	-	0.875 (22.2)	1.700 (43.2)	-	1	1500	B30-R4300
Fig. 14	B33-118-427	B-427	White	1.500 (38.1)	1.000 (25.4)	-	1.125 (28.6)	1.700 (43.2)	0.375 (9.5)	1	1250	B30-R4300
Fig. 14	B33-119-427	B-427	White	1.500 (38.1)	1.500 (38.1)	-	1.750 (44.5)	1.700 (43.2)	0.500 (12.7)	1	1000	B30-R4300
Fig. 14	B33-272-427	B-427	White	1.500 (38.1)	2.250 (57.2)	-	2.500 (63.5)	1.700 (43.2)	0.750 (19.1)	1	700	B30-R4300
Fig. 14	B33-120-427	B-427	White	1.750 (44.5)	1.000 (25.4)	-	1.125 (28.6)	1.950 (49.5)	0.375 (9.5)	1	1250	B30-R4300
Fig. 14	B33-121-427	B-427	White	1.750 (44.5)	1.500 (38.1)	-	1.750 (44.5)	1.950 (49.5)	0.500 (12.7)	1	1000	B30-R4300
Fig. 14	B33-273-427	B-427	White	1.750 (44.5)	2.250 (57.2)	-	2.500 (63.5)	1.950 (49.5)	0.750 (19.1)	1	500	B30-R4300
Fig. 9a	B33-137-427AW	B-427	White	2.000 (50.8)	1.000 (25.4)	-	1.125 (28.6)	2.200 (55.9)	-	1	1500	B30-R4300
Fig. 14	B33-27-427	B-427	White	2.000 (50.8)	3.750 (95.3)	-	4.000 (101.6)	2.200 (55.9)	1.000 (25.4)	1	400	B30-R4300
Fig. 14	B33-26-427	B-427	White	2.500 (63.5)	2.250 (57.2)	-	2.438 (61.9)	2.700 (68.8)	0.750 (19.1)	1	500	B30-R4300
Fig. 14	B33-82-427	B-427	White	2.000 (50.8)	6.000 (152.4)	-	6.187 (157.1)	2.200 (55.9)	1.500 (38.1)	1	200	B30-R4300

Zero-Halogen Cable Markers (B-7643)

Thermoplastic Polyether Polyurethane is a zero-halogen high-density, thermoplastic cable marker designed for dot matrix or thermal-transfer printing.

- Meets the requirements of a halogen-free material per IEC 61249-2-21 (2003-11)
- Excellent chemical, oil and water resistance
- RoHS compliant using EU Directive 2002/95/EC
- Operating temperature of -40°F to 193°F (-40°C to 90°C)

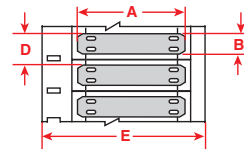

Figure 61



Diagram	Catalog #	B#	Color	Label Width A Inch (mm)	Label Height B Inch (mm)	Labels Per Row	Labels Per Roll	Rec. Ribbon
Fig. 61	B33-6010-7643-WT	B-7643	White	2.36 (60)	0.39 (9.91)	1	500	B30-R6000
Fig. 61	B33-7525-7643-WT	B-7643	White	2.95 (75)	0.98 (24.9)	1	250	B30-R6000
Fig. 61	B33-7510-7643-WT	B-7643	White	2.95 (75)	0.39 (9.91)	1	500	B30-R6000
Fig. 61	B33-7515-7643-WT	B-7643	White	2.95 (75)	0.59 (14.9)	1	500	B30-R6000
Fig. 61	B33-6010-7643-YL	B-7643	Yellow	2.36 (60)	0.39 (9.91)	1	500	B30-R6000
Fig. 61	B33-7525-7643-YL	B-7643	Yellow	2.95 (75)	0.98 (24.9)	1	250	B30-R6000
Fig. 61	B33-7510-7643-YL	B-7643	Yellow	2.95 (75)	0.39 (9.91)	1	500	B30-R6000
Fig. 61	B33-7515-7643-YL	B-7643	Yellow	2.95 (75)	0.59 (14.9)	1	500	B30-R6000

All part numbers above are compatible with BradyPrinter i3300 and BBP®33. Parts may also be compatible with BradyPrinter S3000, BradyPrinter S3100, BBP®30, BBP®31, BBP®35 and BBP®37 printers. Visit BradyID.com to confirm compatibility.

High-Temp Adhesive Topcoated Polyvinylfluoride Wire and Cable Labels (B-437)

- Topcoated polyvinylfluoride label for wire and cable marking where high temperature and self-extinguishing features are required
- Heavy duty performance with excellent resistance to water, oil and other fluids
- Meets MIL-M-87958 Standard

Service temp: -94°F to 275°F
Agency approvals: **RoHS**

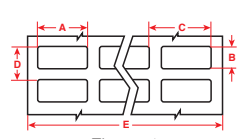

Figure 1

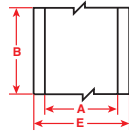

Figure 3

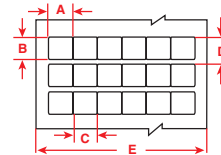
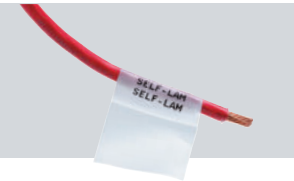

Figure 4

Diagram	Catalog #	B#	Color	Label Width A Inch (mm)	Label Height B Inch (mm)	Horiz. Repeat C Inch (mm)	Vert. Repeat D Inch (mm)	Web Width E Inch (mm)	Labels Per Row	Labels Per Roll	Rec. Ribbon
Fig. 4	B33-11-437	B-437	White	0.250 (6.4)	0.250 (6.4)	0.250 (6.4)	0.375 (9.5)	3.200 (81.3)	12	15000	B30-R4300
Fig. 1	B33-1-437	B-437	White	0.750 (19.1)	0.250 (6.4)	0.800 (20.3)	0.350 (8.9)	3.350 (85.1)	4	5000	B30-R4300
Fig. 1	B33-2-437	B-437	White	0.900 (22.9)	0.250 (6.4)	1.125 (28.6)	0.350 (8.9)	3.350 (85.1)	3	5000	B30-R4300
Fig. 1	B33-5-437	B-437	White	1.000 (25.4)	0.500 (12.7)	1.075 (27.3)	0.600 (15.2)	3.350 (85.1)	3	5000	B30-R4300
Fig. 1	B33-29-437	B-437	White	1.250 (31.8)	0.375 (9.5)	1.300 (33.0)	0.475 (12.1)	2.750 (69.9)	2	5000	B30-R4300
Fig. 1	B33-5-437YL	B-437	Yellow	1.000 (25.4)	0.500 (12.7)	1.075 (27.3)	0.600 (15.2)	3.350 (85.1)	3	5000	B30-R4300
Fig. 1	B33-29-437YL	B-437	Yellow	1.250 (31.8)	0.375 (9.5)	1.300 (33.0)	0.475 (12.1)	2.750 (69.9)	2	5000	B30-R4300
Continuous Rolls:											
Fig. 3	B33C-1000-437	B-437	White	1.000 (25.4)	85 ft. (25.9m)	-	-	1.200 (30.5)	1 roll (cont.)		B30-R4300
Fig. 3	B33C-1500-437	B-437	White	1.500 (38.1)	85 ft. (25.9m)	-	-	1.900 (48.3)	1 roll (cont.)		B30-R4300
Fig. 3	B33C-2000-437	B-437	White	2.000 (50.8)	85 ft. (25.9m)	-	-	2.200 (55.9)	1 roll (cont.)		B30-R4300
Fig. 3	B33C-3000-437	B-437	White	3.000 (76.2)	85 ft. (25.9m)	-	-	3.400 (86.4)	1 roll (cont.)		B30-R4300
Fig. 3	B33C-1000-437YL	B-437	Yellow	1.000 (25.4)	85 ft. (25.9m)	-	-	1.200 (30.5)	1 roll (cont.)		B30-R4300
Fig. 3	B33C-1500-437YL	B-437	Yellow	1.500 (38.1)	85 ft. (25.9m)	-	-	1.900 (48.3)	1 roll (cont.)		B30-R4300
Fig. 3	B33C-2000-437YL	B-437	Yellow	2.000 (50.8)	85 ft. (25.9m)	-	-	2.200 (55.9)	1 roll (cont.)		B30-R4300
Fig. 3	B33C-3000-437YL	B-437	Yellow	3.000 (76.2)	85 ft. (25.9m)	-	-	3.400 (86.4)	1 roll (cont.)		B30-R4300

▶ Also available in self-laminating format

B-437 High-Temp Adhesive Wire and Cable Labels are available in self-laminating format as a custom order. Contact Brady to order B-642 material and B30-R4300 ribbon.



Vinyl Cloth Adhesive Wire and Cable Labels (B-498)

- A vinyl cloth label for marking wires, cables and inside-panel components
- Repositionable – a highly unique adhesive and cloth construction gives excellent holding power and still allows for clean removal and reapplication
- Ideal choice for marking both ends of a wire that you may need to cut shorter before final termination

Service temp: -40°F to 175°F
Agency approvals: **UL RoHS CE**

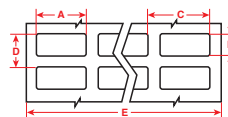
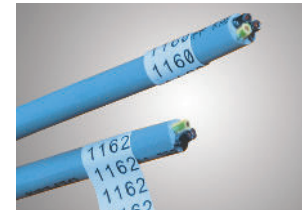

Figure 1

Diagram	Catalog #	B#	Color	Label Width A Inch (mm)	Label Height B Inch (mm)	Horiz. Repeat C Inch (mm)	Vert. Repeat D Inch (mm)	Web Width E Inch (mm)	Labels Per Row	Labels Per Roll	Rec. Ribbon
Fig. 1	B33-90-498	B-498	White	0.250 (6.4)	1.437 (36.5)	0.350 (8.9)	1.562 (39.7)	2.200 (55.9)	6	2500	B30-R6200
Fig. 1	B33-68-498	B-498	White	0.500 (12.7)	0.750 (19.1)	0.600 (15.2)	0.875 (22.2)	2.500 (63.5)	4	5000	B30-R6200
Fig. 1	B33-87-498	B-498	White	0.500 (12.7)	1.437 (36.5)	0.600 (15.2)	1.562 (39.7)	3.700 (94)	6	2500	B30-R6200
Fig. 1	B33-1-498	B-498	White	0.750 (19.1)	0.250 (6.4)	0.800 (20.3)	0.350 (8.9)	3.350 (85.1)	4	5000	B30-R6200
Fig. 1	B33-91-498	B-498	White	0.750 (19.1)	0.937 (23.8)	0.850 (21.6)	1.062 (27.0)	3.500 (88.9)	4	2500	B30-R6200
Fig. 1	B33-95-498	B-498	White	0.800 (20.3)	1.437 (36.5)	0.900 (22.9)	1.562 (39.7)	2.800 (71.1)	3	2300	B30-R6200
Fig. 1	B33-5-498	B-498	White	1.000 (25.4)	0.500 (12.7)	1.075 (27.3)	0.600 (15.2)	3.350 (85.1)	3	5000	B30-R6200
Fig. 1	B33-88-498	B-498	White	1.000 (25.4)	0.750 (19.1)	1.100 (27.9)	0.875 (22.2)	2.300 (58.4)	2	2500	B30-R6200
Fig. 1	B33-89-498	B-498	White	1.000 (25.4)	1.437 (36.5)	1.100 (27.9)	1.562 (39.7)	3.400 (86.4)	3	2300	B30-R6200

All part numbers above are compatible with BradyPrinter i3300 and BBP®33. arts may also be compatible with BradyPrinter S3000, BradyPrinter S3100, BBP®30, BBP®31, BBP®35 and BBP®37 printers. Visit BradyID.com to confirm compatibility.

High-Temp Adhesive Wire and Cable Labels – Polyimide (B-472)

- Topcoated Polyimide label for wire and cable marking where high temperature and self-extinguishing features are required
- Heavy duty performance with excellent resistance to water, oil and other fluids

Service temp: -94°F to 320°F
Agency approvals: **RoHS**

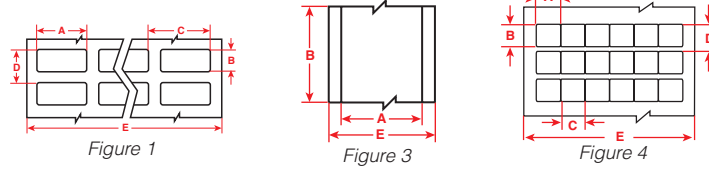

Diagram	Catalog #	B#	Color	Label Width A Inch (mm)	Label Height B Inch (mm)	Horiz. Repeat C Inch (mm)	Vert. Repeat D Inch (mm)	Web Width E Inch (mm)	Labels Per Row	Labels Per Roll	Rec. Ribbon
Fig. 4	B33-11-472	B-472	White	0.250 (6.4)	0.250 (6.4)	0.250 (6.4)	0.375 (9.5)	3.200 (81.3)	12	15000	B30-R4300
Fig. 1	B33-1-472	B-472	White	0.750 (19.1)	0.250 (6.4)	0.800 (20.3)	0.350 (8.9)	3.350 (85.1)	4	5000	B30-R4300
Fig. 1	B33-2-472	B-472	White	0.900 (22.9)	0.250 (6.4)	1.125 (28.6)	0.350 (8.9)	3.350 (85.1)	3	5000	B30-R4300
Fig. 1	B33-5-472	B-472	White	1.000 (25.4)	0.500 (12.7)	1.075 (27.3)	0.600 (15.2)	3.350 (85.1)	3	5000	B30-R4300
Fig. 1	B33-29-472	B-472	White	1.250 (31.8)	0.375 (9.5)	1.300 (33.0)	0.475 (12.1)	2.750 (69.9)	2	5000	B30-R4300
Fig. 1	B33-5-472YL	B-472	Yellow	1.000 (25.4)	0.500 (12.7)	1.075 (27.3)	0.600 (15.2)	3.350 (85.1)	3	5000	B30-R4300
Fig. 1	B33-29-472YL	B-472	Yellow	1.250 (31.8)	0.375 (9.5)	1.300 (33.0)	0.475 (12.1)	2.750 (69.9)	2	5000	B30-R4300
Continuous Rolls:											
Fig. 3	B33C-1000-472	B-472	White	1.000 (25.4)	85ft (25.9m)	-	-	1.200 (30.5)	1 roll (cont.)		B30-R4300
Fig. 3	B33C-1500-472	B-472	White	1.500 (38.1)	85ft (25.9m)	-	-	1.900 (48.3)	1 roll (cont.)		B30-R4300
Fig. 3	B33C-2000-472	B-472	White	2.000 (50.8)	85ft (25.9m)	-	-	2.200 (55.9)	1 roll (cont.)		B30-R4300
Fig. 3	B33C-3000-472	B-472	White	3.000 (76.2)	85ft (25.9m)	-	-	3.400 (86.4)	1 roll (cont.)		B30-R4300
Fig. 3	B33C-1000-472YL	B-472	Yellow	1.000 (25.4)	85ft (25.9m)	-	-	1.200 (30.5)	1 roll (cont.)		B30-R4300
Fig. 3	B33C-1500-472YL	B-472	Yellow	1.500 (38.1)	85ft (25.9m)	-	-	1.900 (48.3)	1 roll (cont.)		B30-R4300
Fig. 3	B33C-2000-472YL	B-472	Yellow	2.000 (50.8)	85ft (25.9m)	-	-	2.200 (55.9)	1 roll (cont.)		B30-R4300
Fig. 3	B33C-3000-472YL	B-472	Yellow	3.000 (76.2)	85ft (25.9m)	-	-	3.400 (86.4)	1 roll (cont.)		B30-R4300

Terminal Block Adhesive Strips (B-498)

- Specially designed narrow-width continuous label for alignment on terminal blocks and patch panels
- Highly unique adhesive and vinyl cloth construction gives excellent holding power and still allows for clean removal and reapplication

Service temp: -40°F to 175°F

Agency approvals: **UL RoHS**

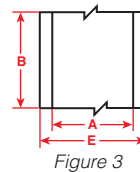

Diagram	Catalog #	B#	Color	Label Width A Inch (mm)	Roll Length B Feet (m)	Web Width E Inch (mm)	Labels Per Roll	Rec. Ribbon
Fig. 3	B33C-312-498	B-498	White	0.312 (7.9)	85 (25.9)	1.000 (25.4)	1 roll (cont.)	B30-R6200
Fig. 3	B33C-375-498	B-498	White	0.375 (9.5)	85 (25.9)	1.000 (25.4)	1 roll (cont.)	B30-R6200

Patch Panel Adhesive Strips (B-422)

- Continuous supply in 3 widths to make labeling patch panels and other datacomm components quick and easy
- Aggressive adhesive suitable for rough, highly textured and powder-coated surfaces as well as smooth surfaces

Service temp: -40°F to 212°F

Agency approvals: **UL RoHS**

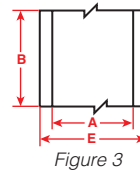

Diagram	Catalog #	B#	Color	Label Width A Inch (mm)	Roll Length B Feet (m)	Web Width E Inch (mm)	Labels Per Roll	Rec. Ribbon
Fig. 3	B33C-312-422	B-422	White	0.312 (7.9)	85 (25.9)	1.000 (25.4)	1 roll (cont.)	B30-R6000
Fig. 3	B33C-375-422	B-422	White	0.375 (9.5)	85 (25.9)	1.000 (25.4)	1 roll (cont.)	B30-R6000

All part numbers above are compatible with BradyPrinter i3300 and BBP®33. Parts may also be compatible with BradyPrinter S3000, BradyPrinter S3100, BBP®30, BBP®31, BBP®35 and BBP®37 printers. Visit BradyID.com to confirm compatibility.

PermaSleeve® PS Polyolefin Wire Marking Sleeves (B-342)

Standard Military/Industrial Grade. 3:1 Shrink ratio.

- A 3:1 heat-shrinkable wire marker sleeve that fits snugly around wires
- Can be used for identification or wire protection
- Fade-resistant and flame-retardant
- Meets the following insulating and physical property specifications:
 - SAE-AS-23053/5 and SAE-AS-81531
 - Tested per ASTM E162, ASTM E662 and MIL-STD-202

Service temp: -40°F to 267°F
 (short burst max temp: 5 min at 500°F, 24 hrs at 350°F)
 Agency approvals:  

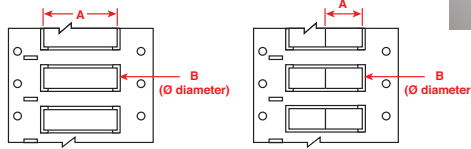



Figure 20

Figure 20-2

Diagram	Catalog #	Material	Color	For Wire Gauge (approx.)	Range For Wire Diameters Inch (mm)	Supplied Diameter B Inch (mm)	Recovered Diameter Inch (mm)	Recovered Wall Thickness Inch (mm)	Sleeves Per Row	Per Roll	Rec. Ribbon
3:1 Shrink ratio single-side printable, 2" sleeve width (dimension A):											
Fig. 20	* B33-94-2-342	B-342	White	28 to 20	0.023 (0.6) - 0.080 (2.0)	0.094 (2.4)	0.024 (0.6)	.024 (0.6) +/- .003 (0.07)	1	1000	B30-R4300
Fig. 20	* B33-125-2-342	B-342	White	22 to 16	0.046 (1.2) - 1.110 (2.8)	0.125 (3.2)	0.047 (1.2)	.020 (0.5) +/- .003 (0.07)	1	1000	B30-R4300
Fig. 20	* B33-187-2-342	B-342	White	20 to 10	0.062 (1.6) - 0.150 (3.8)	0.187 (4.7)	0.062 (1.6)	.020 (0.5) +/- .003 (0.07)	1	750	B30-R4300
Fig. 20	* B33-250-2-342	B-342	White	16 to 8	0.094 (2.4) - 0.215 (5.5)	0.250 (6.4)	0.093 (2.4)	.025 (0.6) +/- .003 (0.07)	1	500	B30-R4300
Fig. 20	* B33-375-2-342	B-342	White	12 to 4	0.125 (3.2) - 0.320 (8.1)	0.375 (9.5)	0.125 (3.1)	.025 (0.6) +/- .003 (0.07)	1	500	B30-R4300
Fig. 20	* B33-500-2-342	B-342	White	8 to 1	0.187 (4.8) - 0.450 (11.4)	0.500 (12.7)	0.187 (4.7)	.025 (0.6) +/- .003 (0.07)	1	350	B30-R4300
Fig. 20	* B33-750-2-342	B-342	White	6 to 4/0	0.250 (6.4) - 0.700 (17.8)	0.750 (19.0)	0.250 (6.4)	.025 (0.6) +/- .003 (0.07)	1	250	B30-R4300
Fig. 20	* B33-1000-2-342	B-342	White	2 to 0.950 dia	0.333 (8.5) - 0.950 (24.1)	1.000 (25.4)	0.375 (9.5)	.036 (0.9) +/- .003 (0.07)	1	250	B30-R4300
Fig. 20	* B33-1500-2-342	B-342	White	n/a	0.500 (12.7) - 1.400 (35.6)	1.500 (38.1)	0.500 (12.7)	.035 (0.9) +/- .003 (0.07)	1	150	B30-R4300
Fig. 20	* B33-94-2-342YL	B-342	Yellow	28 to 20	0.023 (0.6) - 0.080 (2.0)	0.094 (2.4)	0.024 (0.6)	.024 (0.6) +/- .003 (0.07)	1	1000	B30-R4300
Fig. 20	* B33-125-2-342YL	B-342	Yellow	22 to 16	0.046 (1.2) - 1.110 (2.8)	0.125 (3.2)	0.047 (1.2)	.020 (0.5) +/- .003 (0.07)	1	1000	B30-R4300
Fig. 20	* B33-187-2-342YL	B-342	Yellow	20 to 10	0.062 (1.6) - 0.150 (3.8)	0.187 (4.7)	0.062 (1.6)	.020 (0.5) +/- .003 (0.07)	1	750	B30-R4300
Fig. 20	* B33-250-2-342YL	B-342	Yellow	16 to 8	0.094 (2.4) - 0.215 (5.5)	0.250 (6.4)	0.093 (2.4)	.025 (0.6) +/- .003 (0.07)	1	500	B30-R4300
Fig. 20	* B33-375-2-342YL	B-342	Yellow	12 to 4	0.125 (3.2) - 0.320 (8.1)	0.375 (9.5)	0.125 (3.1)	.025 (0.6) +/- .003 (0.07)	1	500	B30-R4300
Fig. 20	* B33-500-2-342YL	B-342	Yellow	8 to 1	0.187 (4.8) - 0.450 (11.4)	0.500 (12.7)	0.187 (4.7)	.025 (0.6) +/- .003 (0.07)	1	350	B30-R4300
Fig. 20	* B33-750-2-342YL	B-342	Yellow	6 to 4/0	0.250 (6.4) - 0.700 (17.8)	0.750 (19.0)	0.250 (6.4)	.025 (0.6) +/- .003 (0.07)	1	250	B30-R4300
Fig. 20	* B33-1000-2-342YL	B-342	Yellow	2 to 0.950 dia	0.333 (8.5) - 0.950 (24.1)	1.000 (25.4)	0.375 (9.5)	.036 (0.9) +/- .003 (0.07)	1	250	B30-R4300
Fig. 20	* B33-1500-2-342YL	B-342	Yellow	n/a	0.500 (12.7) - 1.400 (35.6)	1.500 (38.1)	0.500 (12.7)	.035 (0.9) +/- .003 (0.07)	1	150	B30-R4300
Fig. 20	* B33-1500-2-342BK	B-342	Black	n/a	0.500 (12.7) - 1.400 (35.6)	1.500 (38.1)	0.500 (12.7)	.035 (0.9) +/- .003 (0.07)	1	150	B30-R4500-SV
3:1 Shrink ratio single-side printable, 1" sleeve width in "2-up pre-cut" configuration (dimension A):											
Fig. 20-2	* B33-94-2-342-2	B-342	White	28 to 20	0.023 (0.6) - 0.080 (2.0)	0.094 (2.4)	0.024 (0.6)	.024 (0.6) +/- .003 (0.07)	2	2000	B30-R4300
Fig. 20-2	* B33-125-2-342-2	B-342	White	22 to 16	0.046 (1.2) - 0.111 (2.8)	0.125 (3.2)	0.047 (1.2)	.020 (0.5) +/- .003 (0.07)	2	2000	B30-R4300
Fig. 20-2	* B33-187-2-342-2	B-342	White	20 to 10	0.062 (1.6) - 0.150 (3.8)	0.187 (4.7)	0.062 (1.6)	.020 (0.5) +/- .003 (0.07)	2	1500	B30-R4300
Fig. 20-2	* B33-250-2-342-2	B-342	White	16 to 8	0.094 (2.4) - 0.215 (5.5)	0.250 (6.4)	0.093 (2.4)	.025 (0.6) +/- .003 (0.07)	2	1000	B30-R4300
Fig. 20-2	* B33-375-2-342-2	B-342	White	12 to 4	0.125 (3.2) - 0.320 (8.1)	0.375 (9.5)	0.125 (3.1)	.025 (0.6) +/- .003 (0.07)	2	1000	B30-R4300
Fig. 20-2	* B33-500-2-342-2	B-342	White	8 to 1	0.187 (4.8) - 0.450 (11.4)	0.500 (12.7)	0.119 (3.0)	.025 (0.6) +/- .003 (0.07)	2	700	B30-R4300
Fig. 20-2	* B33-750-2-342-2	B-342	White	6 to 4/0	0.250 (6.4) - 0.700 (17.8)	0.750 (19.1)	0.250 (6.35)	.025 (0.6) +/- .003 (0.07)	2	500	B30-R4300
Fig. 20-2	* B33-1000-2-342-2	B-342	White	2 to 0.950 dia	0.333 (8.5) - 0.950 (24.1)	1.000 (25.4)	0.375 (9.5)	.036 (0.9) +/- .003 (0.07)	2	500	B30-R4300
Fig. 20-2	* B33-1500-2-342-2	B-342	White	n/a	0.500 (12.7) - 1.400 (35.6)	1.500 (38.1)	0.500 (12.7)	.035 (0.9) +/- .003 (0.07)	2	150	B30-R4300
Fig. 20-2	* B33-94-2-342YL-2	B-342	Yellow	28 to 20	0.023 (0.6) - 0.080 (2.0)	0.094 (2.4)	0.024 (0.6)	.024 (0.6) +/- .003 (0.07)	2	2000	B30-R4300
Fig. 20-2	* B33-125-2-342YL-2	B-342	Yellow	22 to 16	0.046 (1.2) - 0.111 (2.8)	0.125 (3.2)	0.047 (1.2)	.020 (0.5) +/- .003 (0.07)	2	2000	B30-R4300
Fig. 20-2	* B33-750-2-342YL-2	B-342	Yellow	6 to 4/0	0.250 (6.4) - 0.700 (17.8)	0.750 (19.1)	0.250 (6.35)	.025 (0.6) +/- .003 (0.07)	2	500	B30-R4300
Fig. 20-2	* B33-500-2-342YL-2	B-342	Yellow	8 to 1	0.187 (4.8) - 0.450 (11.4)	0.500 (12.7)	0.119 (3.0)	.025 (0.6) +/- .003 (0.07)	2	700	B30-R4300
Fig. 20-2	* B33-1000-2-342YL-2	B-342	Yellow	2 to 0.950 dia	0.333 (8.5) - 0.950 (24.1)	1.000 (25.4)	0.375 (9.5)	.036 (0.9) +/- .003 (0.07)	2	500	B30-R4300
Fig. 20-2	* B33-1500-2-342YL-2	B-342	Yellow	n/a	0.500 (12.7) - 1.400 (35.6)	1.500 (38.1)	0.500 (12.7)	.035 (0.9) +/- .003 (0.07)	2	300	B30-R4300

*  **WARNING:** Cancer www.P65Warnings.ca.gov

All part numbers above are compatible with BradyPrinter i3300 and BBP®33. Parts may also be compatible with BradyPrinter S3000, BradyPrinter S3100, BBP®30, BBP®31, BBP®35 and BBP®37 printers. Visit BradyID.com to confirm compatibility.

B-342 PermaSleeve® PS Polyolefin Wire Marking Sleeves (Continued)

Diagram	Catalog #	Material	Color	For Wire Gauge (approx.)	Range For Wire Diameters Inch (mm)	Supplied Diameter B Inch (mm)	Recovered Diameter Inch (mm)	Recovered Wall Thickness Inch (mm)	Sleeves Per Row	Per Roll	Rec. Ribbon
3:1 Shrink ratio double-side printable, 2" sleeve width (dimension A):											
Fig. 20	* B33D-94-2-342	B-342	White	28 to 20	0.023 (0.6) - 0.080 (2.0)	0.094 (2.4)	0.024 (0.6)	.024 (0.6) +/- .003 (0.07)	1	1000	B30-R4300
Fig. 20	* B33D-125-2-342	B-342	White	22 to 16	0.046 (1.2) - 1.110 (2.8)	0.125 (3.2)	0.047 (1.2)	.020 (0.5) +/- .003 (0.07)	1	1000	B30-R4300
Fig. 20	* B33D-125-2-342-2	B-342	White	22 to 16	0.046 (1.2) - 1.110 (2.8)	0.125 (3.2)	0.047 (1.2)	.020 (0.5) +/- .003 (0.07)	2	2000	B30-R4300
Fig. 20	* B33D-187-2-342	B-342	White	20 to 10	0.062 (1.6) - 0.150 (3.8)	0.187 (4.7)	0.062 (1.6)	.020 (0.5) +/- .003 (0.07)	1	750	B30-R4300
Fig. 20	* B33D-250-2-342	B-342	White	16 to 8	0.094 (2.4) - 0.215 (5.5)	0.250 (6.4)	0.093 (2.4)	.025 (0.6) +/- .003 (0.07)	1	500	B30-R4300
Fig. 20	* B33D-375-2-342	B-342	White	12 to 4	0.125 (3.2) - 0.320 (8.1)	0.375 (9.5)	0.125 (3.1)	.025 (0.6) +/- .003 (0.07)	1	500	B30-R4300
Fig. 20	* B33D-500-2-342	B-342	White	8 to 1	0.187 (4.8) - 0.450 (11.4)	0.500 (12.7)	0.187 (4.7)	.025 (0.6) +/- .003 (0.07)	1	350	B30-R4300
Fig. 20	* B33D-750-2-342	B-342	White	6 to 4/0	0.250 (6.4) - 0.700 (17.8)	0.750 (19.0)	0.250 (6.4)	.025 (0.6) +/- .003 (0.07)	1	250	B30-R4300
Fig. 20	* B33D-1000-2-342	B-342	White	2 to 0.950 dia	0.333 (8.5) - 0.950 (24.1)	1.000 (25.4)	0.375 (9.5)	.036 (0.9) +/- .003 (0.07)	1	250	B30-R4300
Fig. 20	* B33D-1500-2-342	B-342	White	n/a	0.500 (12.7) - 1.400 (35.6)	1.500 (38.1)	0.500 (12.7)	.035 (0.9) +/- .003 (0.07)	1	150	B30-R4300
Fig. 20	* B33D-94-2-342YL	B-342	Yellow	28 to 20	0.023 (0.6) - 0.080 (2.0)	0.094 (2.4)	0.024 (0.6)	.024 (0.6) +/- .003 (0.07)	1	1000	B30-R4300
Fig. 20	* B33D-125-2-342YL	B-342	Yellow	22 to 16	0.046 (1.2) - 1.110 (2.8)	0.125 (3.2)	0.047 (1.2)	.020 (0.5) +/- .003 (0.07)	1	1000	B30-R4300
Fig. 20	* B33D-187-2-342YL	B-342	Yellow	20 to 10	0.062 (1.6) - 0.150 (3.8)	0.187 (4.7)	0.062 (1.6)	.020 (0.5) +/- .003 (0.07)	1	750	B30-R4300
Fig. 20	* B33D-250-2-342YL	B-342	Yellow	16 to 8	0.094 (2.4) - 0.215 (5.5)	0.250 (6.4)	0.093 (2.4)	.025 (0.6) +/- .003 (0.07)	1	500	B30-R4300
Fig. 20	* B33D-375-2-342YL	B-342	Yellow	12 to 4	0.125 (3.2) - 0.320 (8.1)	0.375 (9.5)	0.125 (3.1)	.025 (0.6) +/- .003 (0.07)	1	500	B30-R4300
Fig. 20	* B33D-500-2-342YL	B-342	Yellow	8 to 1	0.187 (4.8) - 0.450 (11.4)	0.500 (12.7)	0.187 (4.7)	.025 (0.6) +/- .003 (0.07)	1	350	B30-R4300
Fig. 20	* B33D-750-2-342YL	B-342	Yellow	6 to 4/0	0.250 (6.4) - 0.700 (17.8)	0.750 (19.0)	0.250 (6.4)	.025 (0.6) +/- .003 (0.07)	1	250	B30-R4300
Fig. 20	* B33D-1000-2-342YL	B-342	Yellow	2 to 0.950 dia	0.333 (8.5) - 0.950 (24.1)	1.000 (25.4)	0.375 (9.5)	.036 (0.9) +/- .003 (0.07)	1	250	B30-R4300
Fig. 20	* B33D-1500-2-342YL	B-342	Yellow	n/a	0.500 (12.7) - 1.400 (35.6)	1.500 (38.1)	0.500 (12.7)	.035 (0.9) +/- .003 (0.07)	1	150	B30-R4300
Fig. 20	* B33D-94-2-342BK	B-342	Black	28 to 20	0.023 (0.6) - 0.080 (2.0)	0.094 (2.4)	0.024 (0.6)	.024 (0.6) +/- .003 (0.07)	1	1000	B30-R4500-SV
Fig. 20	* B33D-125-2-342BK	B-342	Black	22 to 16	0.046 (1.2) - 1.110 (2.8)	0.125 (3.2)	0.047 (1.2)	.020 (0.5) +/- .003 (0.07)	1	1000	B30-R4500-SV
Fig. 20	* B33D-187-2-342BK	B-342	Black	20 to 10	0.062 (1.6) - 0.150 (3.8)	0.187 (4.7)	0.062 (1.6)	.020 (0.5) +/- .003 (0.07)	1	750	B30-R4500-SV
Fig. 20	* B33D-250-2-342BK	B-342	Black	16 to 8	0.094 (2.4) - 0.215 (5.5)	0.250 (6.4)	0.093 (2.4)	.025 (0.6) +/- .003 (0.07)	1	500	B30-R4500-SV
Fig. 20	* B33D-375-2-342BK	B-342	Black	12 to 4	0.125 (3.2) - 0.320 (8.1)	0.375 (9.5)	0.125 (3.1)	.025 (0.6) +/- .003 (0.07)	1	500	B30-R4500-SV
Fig. 20	* B33D-500-2-342BK	B-342	Black	8 to 1	0.187 (4.8) - 0.450 (11.4)	0.500 (12.7)	0.187 (4.7)	.025 (0.6) +/- .003 (0.07)	1	350	B30-R4500-SV
Fig. 20	* B33D-750-2-342BK	B-342	Black	6 to 4/0	0.250 (6.4) - 0.700 (17.8)	0.750 (19.0)	0.250 (6.4)	.025 (0.6) +/- .003 (0.07)	1	250	B30-R4500-SV
Fig. 20	* B33D-1000-2-342BK	B-342	Black	2 to 0.950 dia	0.333 (8.5) - 0.950 (24.1)	1.000 (25.4)	0.375 (9.5)	.036 (0.9) +/- .003 (0.07)	1	250	B30-R4500-SV
Fig. 20	* B33D-1500-2-342BK	B-342	Black	n/a	0.500 (12.7) - 1.400 (35.6)	1.500 (38.1)	0.500 (12.7)	.035 (0.9) +/- .003 (0.07)	1	150	B30-R4500-SV

*  **WARNING:** Cancer www.P65Warnings.ca.gov

QuickSleeve Handheld Sleeve Applicator

The QuickSleeve Handheld Sleeve Applicator is an intuitive multi-tool designed to help you quickly apply sleeves on to wires in three simple steps – just pick, slip and apply. This tool includes:

- Four specially designed slanted tubes sized for sleeve sizes 0.094, 0.125, 0.187 and 0.250 inches
- Built-in LED flashlight for use in low-lit conditions
- Terminal block sized screwdriver



Catalog #	Description	Qty.
QS	QuickSleeve multi-tool	1 Set

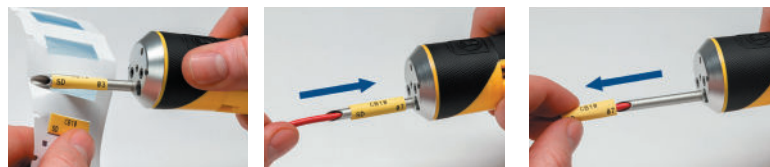

Pick

Slip

Apply

All part numbers above are compatible with BradyPrinter i3300 and BBP®33. Parts may also be compatible with BradyPrinter S3000, BradyPrinter S3100, BBP®30, BBP®31, BBP®35 and BBP®37 printers. Visit BradyID.com to confirm compatibility.

PermaSleeve® HT High-Temperature PVDF Wire Marking Sleeves (B-345)

High temperature, low outgassing. 2:1 Shrink ratio.

- A 2:1 shrink ratio wire marker sleeve specifically designed for high-temperature and low-vacuum outgassing applications
- Made from irradiated high-temp polyvinylidene fluoride (PVDF) heat-shrink tubing
- Fade-resistant and flame-retardant
- Meets the following industry specifications:
 - NASA SP-R-0022A Outgassing Performance
 - SAE-AS-81531
 - Tested per ASTM E162, ASTM E662 and MIL-STD-202

Service temp: -67°F to 437°F Agency approvals: RoHS

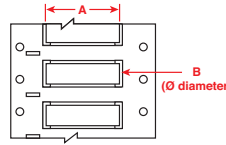

Figure 20



Diagram	Catalog #	Material	Color	For Wire Gauge (approx.)	Range For Wire Diameters Inch (mm)	Supplied Diameter B Inch (mm)	Recovered Diameter Inch (mm)	Recovered Wall Thickness Inch (mm)	Sleeves Per Row	Sleeves Per Roll	Rec. Ribbon
3:1 Shrink ratio double-side printable, 2" sleeve width (dimension A):											
Fig. 20	B33D-94-2-345	B-345	White	26 to 20	0.031 (0.8) - 0.080 (2.0)	0.094 (2.4)	0.031 (0.8)	.015 (0.4) +/- .003 (0.07)	1	1000	B30-R6000
Fig. 20	B33D-94-2-345BK	B-345	Black	26 to 20	0.031 (0.8) - 0.080 (2.0)	0.094 (2.4)	0.031 (0.8)	.015 (0.4) +/- .003 (0.07)	1	1000	B30-R4400-WT
2:1 Shrink ratio double-side printable, 2" sleeve width (dimension A):											
Fig. 20	B33D-125-2-345	B-345	White	20 to 16	0.063 (1.6) - 0.110 (2.8)	0.125 (3.2)	0.062 (1.6)	.015 (0.4) +/- .003 (0.07)	1	1000	B30-R6000
Fig. 20	B33D-187-2-345	B-345	White	16 to 10	0.094 (2.4) - 0.150 (3.8)	0.187 (4.7)	0.093 (2.4)	.015 (0.4) +/- .003 (0.07)	1	750	B30-R6000
Fig. 20	B33D-250-2-345	B-345	White	12 to 8	0.125 (3.2) - 0.215 (5.5)	0.250 (6.4)	0.125 (3.2)	.015 (0.4) +/- .003 (0.07)	1	500	B30-R6000
Fig. 20	B33D-375-2-345	B-345	White	8 to 4	0.187 (3.2) - 0.320 (8.1)	0.375 (9.5)	0.187 (4.7)	.015 (0.4) +/- .003 (0.07)	1	500	B30-R6000
Fig. 20	B33D-500-2-345	B-345	White	6 to 1	0.250 (6.4) - 0.450 (11.4)	0.500 (12.7)	0.250 (6.4)	.015 (0.4) +/- .003 (0.07)	1	350	B30-R6000
Fig. 20	B33D-750-2-345	B-345	White	2 to 4/0	0.375 (9.5) - 0.700 (17.8)	0.750 (19.0)	0.375 (9.5)	.015 (0.4) +/- .003 (0.07)	1	250	B30-R6000
Fig. 20	B33D-1000-2-345	B-345	White	2/0 to 0.950 dia	0.450 (11.4) - 0.950 (24.1)	1.000 (25.4)	0.500 (12.7)	.017 (0.4) +/- .004 (0.1)	1	250	B30-R6000
Fig. 20	B33D-1500-2-345	B-345	White	N/A	0.750 (19.1) - 1.400 (35.6)	1.500 (38.1)	0.750 (19.1)	.024 (0.6) +/- .004 (0.1)	1	150	B30-R6000
Fig. 20	B33D-125-2-345BK	B-345	Black	20 to 16	0.063 (1.6) - 0.110 (2.8)	0.125 (3.2)	0.062 (1.6)	.015 (0.4) +/- .003 (0.07)	1	1000	B30-R4400-WT
Fig. 20	B33D-187-2-345BK	B-345	Black	16 to 10	0.094 (2.4) - 0.150 (3.8)	0.187 (4.7)	0.093 (2.4)	.015 (0.4) +/- .003 (0.07)	1	750	B30-R4400-WT
Fig. 20	B33D-250-2-345BK	B-345	Black	12 to 8	0.125 (3.2) - 0.215 (5.5)	0.250 (6.4)	0.125 (3.2)	.015 (0.4) +/- .003 (0.07)	1	500	B30-R4400-WT
Fig. 20	B33D-375-2-345BK	B-345	Black	8 to 4	0.187 (3.2) - 0.320 (8.1)	0.375 (9.5)	0.187 (4.7)	.015 (0.4) +/- .003 (0.07)	1	500	B30-R4400-WT
Fig. 20	B33D-500-2-345BK	B-345	Black	6 to 1	0.250 (6.4) - 0.450 (11.4)	0.500 (12.7)	0.250 (6.4)	.015 (0.4) +/- .003 (0.07)	1	350	B30-R4400-WT
Fig. 20	B33D-750-2-345BK	B-345	Black	3 to 4/0	0.375 (9.5) - 0.700 (17.8)	0.750 (19.0)	0.375 (9.5)	.015 (0.4) +/- .003 (0.07)	1	250	B30-R4400-WT
Fig. 20	B33D-1000-2-345BK	B-345	Black	2/0 to 0.950 dia	0.450 (11.4) - 0.950 (24.1)	1.000 (25.4)	0.500 (12.7)	.017 (0.4) +/- .004 (0.1)	1	250	B30-R4400-WT
Fig. 20	B33D-1500-2-345BK	B-345	Black	N/A	0.750 (19.1) - 1.400 (35.6)	1.500 (38.1)	0.750 (19.1)	.024 (0.6) +/- .004 (0.1)	1	150	B30-R4400-WT

All part numbers above are compatible with BradyPrinter i3300 and BBP®33. Parts may also be compatible with BradyPrinter S3000, BradyPrinter S3100, BBP®30, BBP®31, BBP®35 and BBP®37 printers. Visit BradyID.com to confirm compatibility.

PermaSleeve® HX Polyolefin Wire Marking Sleeves (B-7642)

Military/Industrial Grade. 2:1 Shrink ratio.

- Flame retardant and high-temp rated but not as high temp as B-345 "HT" sleeves
- Meets the following industry specifications:
 - SAE-AS23053/5 and SAE-AS-81531
 - Tested per ASTM E162, ASTM E662 and MIL-STD-202

Service temp: -40°F to 248°F (short burst max temp: 5 min at 464°F, 24 hrs at 320°F)

Agency approval: RoHS

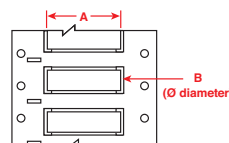

Figure 20



Diagram	Catalog #	Material	Color	For Wire Gauge (approx.)	Range For Wire Diameters Inch (mm)	Supplied Diameter B Inch (mm)	Recovered Diameter Inch (mm)	Recovered Wall Thickness Inch (mm)	Sleeves Per Row	Per Roll	Rec. Ribbon
2:1 Shrink ratio single-side printable, 2" sleeve width (dimension A):											
Fig. 20	B33-94-2-7642	B-7642	White	24 to 20	0.047 (1.2) - 0.080 (2.0)	0.094 (2.4)	0.047 (1.2)	.020 (0.5) +/- .003 (0.07)	1	500	B30-R4300
Fig. 20	B33-125-2-7642	B-7642	White	20 to 16	0.062 (1.6) - 0.110 (2.8)	0.125 (3.2)	0.063 (1.6)	.020 (0.5) +/- .003 (0.07)	1	500	B30-R4300
Fig. 20	B33-187-2-7642	B-7642	White	16 to 10	0.094 (2.4) - 0.151 (3.8)	0.187 (4.8)	0.094 (2.4)	.020 (0.5) +/- .003 (0.07)	1	450	B30-R4300
Fig. 20	B33-250-2-7642	B-7642	White	12 to 8	0.125 (3.2) - 0.215 (5.5)	0.250 (6.4)	0.126 (3.2)	.025 (0.6) +/- .003 (0.07)	1	400	B30-R4300
Fig. 20	B33-375-2-7642	B-7642	White	8 to 4	0.188 (4.8) - 0.320 (8.1)	0.375 (9.5)	0.189 (4.8)	.025 (0.6) +/- .003 (0.07)	1	250	B30-R4300
Fig. 20	B33-500-2-7642	B-7642	White	6 to 1	0.250 (6.4) - 0.450 (11.4)	0.500 (12.7)	0.252 (6.4)	.025 (0.6) +/- .003 (0.07)	1	225	B30-R4300
Fig. 20	B33-750-2-7642	B-7642	White	2 to 4/0	0.375 (9.5) - 0.700 (17.8)	0.750 (19.0)	0.374 (9.5)	.030 (0.8) +/- .003 (0.07)	1	150	B30-R4300
Fig. 20	B33-1000-2-7642	B-7642	White	2/0 to 0.950 dia	0.450 (11.4) - 0.950 (24.1)	1.000 (25.4)	0.500 (12.7)	.035 (0.9) +/- .005 (0.1)	1	150	B30-R4300
Fig. 20	B33-1500-2-7642	B-7642	White	N/A	0.750 (19.0) - 1.400 (35.6)	1.500 (38.1)	0.752 (19.1)	.040 (1.0) +/- .006 (0.2)	1	50	B30-R4300
Fig. 20	B33-2000-2-7642	B-7642	White	N/A	1.000 (25.4) - 1.900 (48.3)	2.000 (50.8)	1.000 (25.4)	.045 (1.1) +/- .007 (0.2)	1	50	B30-R4300
2:1 Shrink ratio double-side printable, 2" sleeve width (dimension A):											
Fig. 20	B33D-94-2-7642	B-7642	White	24 to 20	0.047 (1.2) - 0.080 (2.0)	0.094 (2.4)	0.047 (1.2)	.020 (0.5) +/- .003 (0.07)	1	500	B30-R4300
Fig. 20	B33D-125-2-7642	B-7642	White	20 to 16	0.062 (1.6) - 0.110 (2.8)	0.125 (3.2)	0.063 (1.6)	.020 (0.5) +/- .003 (0.07)	1	500	B30-R4300
Fig. 20	B33D-187-2-7642	B-7642	White	16 to 10	0.094 (2.4) - 0.151 (3.8)	0.187 (4.8)	0.094 (2.4)	.020 (0.5) +/- .003 (0.07)	1	450	B30-R4300
Fig. 20	B33D-250-2-7642	B-7642	White	12 to 8	0.125 (3.2) - 0.215 (5.5)	0.250 (6.4)	0.126 (3.2)	.025 (0.6) +/- .003 (0.07)	1	400	B30-R4300
Fig. 20	B33D-375-2-7642	B-7642	White	8 to 4	0.188 (4.8) - 0.320 (8.1)	0.375 (9.5)	0.189 (4.8)	.025 (0.6) +/- .003 (0.07)	1	250	B30-R4300
Fig. 20	B33D-500-2-7642	B-7642	White	6 to 1	0.250 (6.4) - 0.450 (11.4)	0.500 (12.7)	0.252 (6.4)	.025 (0.6) +/- .003 (0.07)	1	225	B30-R4300
Fig. 20	B33D-750-2-7642	B-7642	White	2 to 4/0	0.375 (9.5) - 0.700 (17.8)	0.750 (19.0)	0.374 (9.5)	.030 (0.8) +/- .003 (0.07)	1	150	B30-R4300
Fig. 20	B33D-1000-2-7642	B-7642	White	2/0 to 0.950 dia	0.450 (11.4) - 0.950 (24.1)	1.000 (25.4)	0.500 (12.7)	.035 (0.9) +/- .005 (0.1)	1	150	B30-R4300
Fig. 20	B33D-1500-2-7642	B-7642	White	N/A	0.750 (19.0) - 1.400 (35.6)	1.500 (38.1)	0.752 (19.1)	.040 (1.0) +/- .006 (0.2)	1	50	B30-R4300
Fig. 20	B33D-2000-2-7642	B-7642	White	N/A	1.000 (25.4) - 1.900 (48.3)	2.000 (50.8)	1.000 (25.4)	.045 (1.1) +/- .007 (0.2)	1	50	B30-R4300

PermaSleeve® LSZH Low Smoke Zero Halogen Polyolefin Wire Marking Sleeves (B-7641)

Military/Industrial Grade. 2:1 Shrink ratio.

- Low halogen wire marking sleeves offer outstanding fire safety properties and minimal smoke emission
- Meets the following industry specifications:
 - SAE-AS-81531 and EN45545-2
 - Tested per ASTM E162, ASTM E662 and MIL-STD-202

Service temp: -22°F to 221°F Agency approval: RoHS

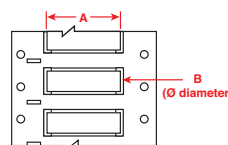

Figure 20



Diagram	Catalog #	Material	Color	Range For Wire Diameters Inch (mm)	Supplied Diameter B Inch (mm)	Recovered Diameter Inch (mm)	Recovered Wall Thickness Inch (mm)	Sleeves Per Row	Per Roll	Rec. Ribbon
2:1 Shrink ratio double-side printable, 2" sleeve width (dimension A):										
Fig. 20	B33D-94-2-7641	B-7641	White	0.047 (1.2) - 0.080 (2.0)	0.094 (2.4)	0.047 (1.2)	.020 (0.5) +/- .003 (0.07)	1	1000	B30-R6000
Fig. 20	B33D-125-2-7641	B-7641	White	0.062 (1.6) - 0.110 (2.8)	0.125 (3.2)	0.063 (1.6)	.020 (0.5) +/- .003 (0.07)	1	1000	B30-R6000
Fig. 20	B33D-187-2-7641	B-7641	White	0.094 (2.4) - 0.151 (3.8)	0.187 (4.8)	0.094 (2.4)	.020 (0.5) +/- .003 (0.07)	1	450	B30-R6000
Fig. 20	B33D-250-2-7641	B-7641	White	0.125 (3.2) - 0.215 (5.5)	0.250 (6.4)	0.126 (3.2)	.025 (0.6) +/- .003 (0.07)	1	500	B30-R6000
Fig. 20	B33D-375-2-7641	B-7641	White	0.188 (4.8) - 0.320 (8.1)	0.375 (9.5)	0.189 (4.8)	.025 (0.6) +/- .003 (0.07)	1	500	B30-R6000
Fig. 20	B33D-500-2-7641	B-7641	White	0.250 (6.4) - 0.450 (11.4)	0.500 (12.7)	0.252 (6.4)	.025 (0.6) +/- .003 (0.07)	1	225	B30-R6000
Fig. 20	B33D-750-2-7641	B-7641	White	0.375 (9.5) - 0.700 (17.8)	0.750 (19.0)	0.374 (9.5)	.030 (0.8) +/- .003 (0.07)	1	150	B30-R6000
Fig. 20	B33D-1000-2-7641	B-7641	White	0.450 (11.4) - 0.950 (24.1)	1.000 (25.4)	0.500 (12.7)	.035 (0.9) +/- .005 (0.1)	1	150	B30-R6000
Fig. 20	B33D-1500-2-7641	B-7641	White	0.750 (19.0) - 1.400 (35.6)	1.500 (38.1)	0.752 (19.1)	.040 (1.0) +/- .006 (0.2)	1	50	B30-R6000
Fig. 20	B33D-94-2-7641Y	B-7641	Yellow	0.047 (1.2) - 0.080 (2.0)	0.094 (2.4)	0.047 (1.2)	.020 (0.5) +/- .003 (0.07)	1	1000	B30-R6000
Fig. 20	B33D-125-2-7641Y	B-7641	Yellow	0.062 (1.6) - 0.110 (2.8)	0.125 (3.2)	0.063 (1.6)	.020 (0.5) +/- .003 (0.07)	1	1000	B30-R6000
Fig. 20	B33D-187-2-7641Y	B-7641	Yellow	0.094 (2.4) - 0.151 (3.8)	0.187 (4.8)	0.094 (2.4)	.020 (0.5) +/- .003 (0.07)	1	450	B30-R6000
Fig. 20	B33D-250-2-7641Y	B-7641	Yellow	0.125 (3.2) - 0.215 (5.5)	0.250 (6.4)	0.126 (3.2)	.025 (0.6) +/- .003 (0.07)	1	500	B30-R6000
Fig. 20	B33D-375-2-7641Y	B-7641	Yellow	0.188 (4.8) - 0.320 (8.1)	0.375 (9.5)	0.189 (4.8)	.025 (0.6) +/- .003 (0.07)	1	500	B30-R6000
Fig. 20	B33D-500-2-7641Y	B-7641	Yellow	0.250 (6.4) - 0.450 (11.4)	0.500 (12.7)	0.252 (6.4)	.025 (0.6) +/- .003 (0.07)	1	225	B30-R6000
Fig. 20	B33D-750-2-7641Y	B-7641	Yellow	0.375 (9.5) - 0.700 (17.8)	0.750 (19.0)	0.374 (9.5)	.030 (0.8) +/- .003 (0.07)	1	150	B30-R6000
Fig. 20	B33D-1000-2-7641Y	B-7641	Yellow	0.450 (11.4) - 0.950 (24.1)	1.000 (25.4)	0.500 (12.7)	.035 (0.9) +/- .005 (0.1)	1	150	B30-R6000
Fig. 20	B33D-1500-2-7641Y	B-7641	Yellow	0.750 (19.0) - 1.400 (35.6)	1.500 (38.1)	0.752 (19.1)	.040 (1.0) +/- .006 (0.2)	1	50	B30-R6000

All part numbers above are compatible with BradyPrinter i3300 and BBP®33. Parts may also be compatible with BradyPrinter S3000, BradyPrinter S3100, BBP®30, BBP®31, BBP®35 and BBP®37 printers. Visit BradyID.com to confirm compatibility.

PermaSleeve® FR Fluid Resistant Wire Marking Sleeves (B-344) Military / Industrial Grade. 3:1 Shrink ratio.

- Designed for labeling wires in applications where they will be exposed to fuels, lubricants and harsh chemicals such as in the installation of hydrogen fuel cells in aerospace
- Resistant to harsh chemicals including JP8 Jet Fuel, Skydrol® and DOT 3 brake fluid
- Meets the following industry specifications:
 - SAE-AS23053/5
 - Tested per: ASTM E162, ASTM E662, MIL-STD-202G

Service temp: -94°F to 267°F

Agency approvals: **RohS**

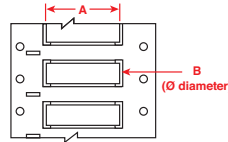

Figure 20

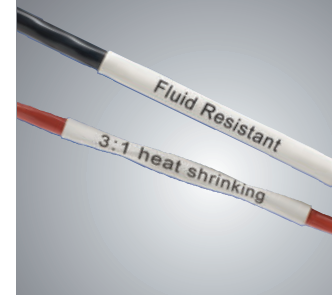

Diagram	Catalog #	Material	Color	For Wire Gauge (approx.)	Range For Wire Diameters Inch (mm)	Supplied Diameter B Inch (mm)	Recovered Diameter Inch (mm)	Recovered Wall Thickness Inch (mm)	Sleeves Per Row	Sleeves Per Roll	Rec. Ribbon
3:1 Shrink ratio double-side printable, 2" sleeve width (dimension A):											
Fig. 20	* B33D-94-2-344	B-344	White	28 to 20	0.023 (0.6) - 0.080 (2.0)	0.094 (2.4)	0.024 (0.6)	0.024 (0.6) +/- 0.003 (0.1)	1	1000	B30-R6600
Fig. 20	* B33D-125-2-344	B-344	White	22 to 16	0.046 (1.2) - 0.111 (2.8)	0.125 (3.1)	0.047 (1.2)	0.020 (0.5) +/- 0.003 (0.1)	1	1000	B30-R6600
Fig. 20	* B33D-187-2-344	B-344	White	20 to 10	0.062 (1.6) - 0.15 (3.81)	0.187 (4.8)	0.062 (1.6)	0.020 (0.5) +/- 0.003 (0.1)	1	750	B30-R6600
Fig. 20	* B33D-250-2-344	B-344	White	16 to 8	0.094 (2.4) - 0.215 (5.5)	0.250 (6.35)	0.093 (2.4)	0.025 (0.6) +/- 0.003 (0.1)	1	500	B30-R6600
Fig. 20	* B33D-375-2-344	B-344	White	12 to 4	0.125 (3.2) - 0.320 (8.1)	0.375 (9.5)	0.125 (3.2)	0.025 (0.6) +/- 0.003 (0.1)	1	500	B30-R6600
Fig. 20	* B33D-500-2-344	B-344	White	8 to 1	0.187 (4.8) - 0.450 (11.4)	0.500 (12.7)	0.119 (3.0)	0.025 (0.6) +/- 0.003 (0.1)	1	350	B30-R6600
Fig. 20	* B33D-750-2-344	B-344	White	6 to 4/0	0.250 (6.4) - 0.700 (17.8)	0.750 (19.05)	0.250 (6.35)	0.025 (0.6) +/- 0.003 (0.1)	1	250	B30-R6600
Fig. 20	* B33D-1000-2-344	B-344	White	2 to 0.950 dia	0.333 (8.5) - 0.950 (24.1)	1.000 (25.4)	0.375 (9.5)	0.036 (0.9) +/- 0.003 (0.1)	1	250	B30-R6600
Fig. 20	* B33D-1500-2-344	B-344	White	n/a	0.500 (12.7) - 1.400 (35.6)	1.500 (38.1)	0.500 (12.7)	0.035 (0.9) +/- 0.003 (0.1)	1	150	B30-R6600
Fig. 20	* B33D-94-2-344YL	B-344	Yellow	28 to 20	0.023 (0.6) - 0.080 (2.0)	0.094 (2.4)	0.024 (0.6)	0.024 (0.6) +/- 0.003 (0.1)	1	1000	B30-R6600
Fig. 20	* B33D-125-2-344YL	B-344	Yellow	22 to 16	0.046 (1.2) - 0.111 (2.8)	0.125 (3.1)	0.047 (1.2)	0.020 (0.5) +/- 0.003 (0.1)	1	1000	B30-R6600
Fig. 20	* B33D-187-2-344YL	B-344	Yellow	20 to 10	0.062 (1.6) - 0.15 (3.81)	0.187 (4.8)	0.062 (1.6)	0.020 (0.5) +/- 0.003 (0.1)	1	750	B30-R6600
Fig. 20	* B33D-250-2-344YL	B-344	Yellow	16 to 8	0.094 (2.4) - 0.215 (5.5)	0.250 (6.35)	0.093 (2.4)	0.025 (0.6) +/- 0.003 (0.1)	1	500	B30-R6600
Fig. 20	* B33D-375-2-344YL	B-344	Yellow	12 to 4	0.125 (3.2) - 0.320 (8.1)	0.375 (9.5)	0.125 (3.2)	0.025 (0.6) +/- 0.003 (0.1)	1	500	B30-R6600
Fig. 20	* B33D-500-2-344YL	B-344	Yellow	8 to 1	0.187 (4.8) - 0.450 (11.4)	0.500 (12.7)	0.119 (3.0)	0.025 (0.6) +/- 0.003 (0.1)	1	350	B30-R6600
Fig. 20	* B33D-750-2-344YL	B-344	Yellow	6 to 4/0	0.250 (6.4) - 0.700 (17.8)	0.750 (19.05)	0.250 (6.35)	0.025 (0.6) +/- 0.003 (0.1)	1	250	B30-R6600
Fig. 20	* B33D-1000-2-344YL	B-344	Yellow	2 to 0.950 dia	0.333 (8.5) - 0.950 (24.1)	1.000 (25.4)	0.375 (9.5)	0.036 (0.9) +/- 0.003 (0.1)	1	250	B30-R6600
Fig. 20	* B33D-1500-2-344YL	B-344	Yellow	n/a	0.500 (12.7) - 1.400 (35.6)	1.500 (38.1)	0.500 (12.7)	0.035 (0.9) +/- 0.003 (0.1)	1	150	B30-R6600
Fig. 20	* B33D-94-2-344BK	B-344	Black	28 to 20	0.023 (0.6) - 0.080 (2.0)	0.094 (2.4)	0.024 (0.6)	0.024 (0.6) +/- 0.003 (0.1)	1	1000	B30-R6700-WT
Fig. 20	* B33D-125-2-344BK	B-344	Black	22 to 16	0.046 (1.2) - 0.111 (2.8)	0.125 (3.1)	0.047 (1.2)	0.020 (0.5) +/- 0.003 (0.1)	1	1000	B30-R6700-WT
Fig. 20	* B33D-187-2-344BK	B-344	Black	20 to 10	0.062 (1.6) - 0.15 (3.81)	0.187 (4.8)	0.062 (1.6)	0.020 (0.5) +/- 0.003 (0.1)	1	750	B30-R6700-WT
Fig. 20	* B33D-250-2-344BK	B-344	Black	16 to 8	0.094 (2.4) - 0.215 (5.5)	0.250 (6.35)	0.093 (2.4)	0.025 (0.6) +/- 0.003 (0.1)	1	500	B30-R6700-WT
Fig. 20	* B33D-375-2-344BK	B-344	Black	12 to 4	0.125 (3.2) - 0.320 (8.1)	0.375 (9.5)	0.125 (3.2)	0.025 (0.6) +/- 0.003 (0.1)	1	500	B30-R6700-WT
Fig. 20	* B33D-500-2-344BK	B-344	Black	8 to 1	0.187 (4.8) - 0.450 (11.4)	0.500 (12.7)	0.119 (3.0)	0.025 (0.6) +/- 0.003 (0.1)	1	350	B30-R6700-WT
Fig. 20	* B33D-750-2-344BK	B-344	Black	6 to 4/0	0.250 (6.4) - 0.700 (17.8)	0.750 (19.05)	0.250 (6.35)	0.025 (0.6) +/- 0.003 (0.1)	1	250	B30-R6700-WT
Fig. 20	* B33D-1000-2-344BK	B-344	Black	2 to 0.950 dia	0.333 (8.5) - 0.950 (24.1)	1.000 (25.4)	0.375 (9.5)	0.036 (0.9) +/- 0.003 (0.1)	1	250	B30-R6700-WT
Fig. 20	* B33D-1500-2-344BK	B-344	Black	n/a	0.500 (12.7) - 1.400 (35.6)	1.500 (38.1)	0.500 (12.7)	0.035 (0.9) +/- 0.003 (0.1)	1	150	B30-R6700-WT

* **WARNING:** Cancer www.P65Warnings.ca.gov

All part numbers above are compatible with BradyPrinter i3300 and BBP®33. Parts may also be compatible with BradyPrinter S3000, BradyPrinter S3100, BBP®30, BBP®31, BBP®35 and BBP®37 printers. Visit BradyID.com to confirm compatibility.

Pre-Printed Pre-Cut Blank Sign Headers (B-595)

- Allows printer to create multicolor signs fast in a single print pass
- Headers meet NFPA 70E, OSHA 1910.145 and ASME/ANSI Z535 standards
- Indoor / outdoor grade material conforms to rough, highly textured and difficult-to-adhere-to surfaces

Service temp: -40°F to 180°F
 Application temp: 0°F to 180°F
 Average outdoor durability: 8-10 years
 Agency approvals: RoHS

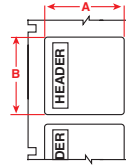

Figure 70



Diagram	Catalog #	B#	Material	Header	Label Height A Inch (mm)	Label Width B Inch (mm)	Labels Per Row	Labels Per Roll	Rec. Ribbon
Fig. 70	B30-241-595-OSHADA	B-595	Vinyl		2.250 (57.5)	3.000 (76.2)	1	300	B30-R10000
Fig. 70	B30-25-595-OSHADA	B-595	Vinyl		4.000 (101.6)	6.000 (152.4)	1	175	B30-R10000
Fig. 70	B30-241-595-OSHACA	B-595	Vinyl		2.250 (57.5)	3.000 (76.2)	1	300	B30-R10000
Fig. 70	B30-25-595-OSHACA	B-595	Vinyl		4.000 (101.6)	6.000 (152.4)	1	175	B30-R10000
Fig. 70	B30-241-595-ANSICA	B-595	Vinyl		2.250 (57.5)	3.000 (76.2)	1	300	B30-R10000
Fig. 70	B30-25-595-ANSICA	B-595	Vinyl		4.000 (101.6)	6.000 (152.4)	1	175	B30-R10000
Fig. 70	B30-241-595-ANSIDA	B-595	Vinyl		2.250 (57.5)	3.000 (76.2)	1	300	B30-R10000
Fig. 70	B30-25-595-ANSIDA	B-595	Vinyl		4.000 (101.6)	6.000 (152.4)	1	175	B30-R10000
Fig. 70	B30-241-595-ANSIWA	B-595	Vinyl		2.250 (57.5)	3.000 (76.2)	1	300	B30-R10000
Fig. 70	B30-25-595-ANSIWA	B-595	Vinyl		4.000 (101.6)	6.000 (152.4)	1	175	B30-R10000
Fig. 70	B30-241-595-ANSINO	B-595	Vinyl		2.250 (57.5)	3.000 (76.2)	1	300	B30-R10000
Fig. 70	B30-25-595-ANSINO	B-595	Vinyl		4.000 (101.6)	6.000 (152.4)	1	175	B30-R10000
Fig. 70	B30-25-595-PREC	B-595	Vinyl		4.000 (101.6)	6.000 (152.4)	1	175	B30-R10000
Fig. 70	B30-25-595-PEL	B-595	Vinyl		4.000 (101.6)	6.000 (152.4)	1	175	B30-R10000
Fig. 70	B30-242-595-BLNKWT	B-595	Vinyl		1.125 (28.6) *	2.750 (69.8)	300	B30-R10000	B30-R10000
Fig. 70	B30-241-595-BLNKWT	B-595	Vinyl		2.250 (57.5)	3.000 (76.2)	300	B30-R10000	B30-R10000
Fig. 70	B30-219-595-BLNKWT	B-595	Vinyl		2.250 (57.5) *	3.750 (95.3)	250	B30-R10000	B30-R10000
Fig. 70	B30-25-595-BLNKWT	B-595	Vinyl		4.000 (101.6)	6.000 (152.4)	175	B30-R10000	B30-R10000
Fig. 70	B30-241-595-BLNKYL	B-595	Vinyl		2.250 (57.5)	3.000 (76.2)	1	300	B30-R10000
Fig. 70	B30-25-595-BLNKYL	B-595	Vinyl		4.000 (101.6)	6.000 (152.4)	1	175	B30-R10000

Non-Adhesive Tags (B-551)

- Non-adhesive semi-rigid card stock in pre-cut and continuous styles
- Tags are pre-cut with hole or easy to hole punch, are micro-perforated between tags to separate cleanly and some feature chamfered corners
- Snap-in plastic grommets available for extra strength around mounting hole (Catalog #20596, 100/bag)

Service temp: -40°F to 193°F
 Average outdoor durability: Up to 2 years

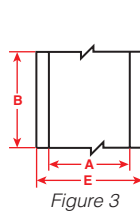

Figure 3

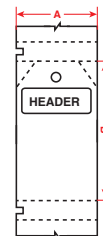

Figure 69



Diagram	Catalog #	B#	Header	Tag Width A Inch (mm)	Tag Height B Inch (mm)	Tags Per Row	Tags Per Roll	Rec. Ribbon
Fig. 69	B30-255-551-ANSIDA	B-551		3.250 (82.6)	5.750 (146.1)	1	100	B30-R10000
Fig. 69	B30-255-551-OSHADA	B-551		3.250 (82.6)	5.750 (146.1)	1	100	B30-R10000
Fig. 69	B30-255-551-ANSICA	B-551		3.250 (82.6)	5.750 (146.1)	1	100	B30-R10000
Fig. 69	B30-255-551-WHT	B-551		3.250 (82.6)	5.750 (146.1)	1	100	B30-R10000
Fig. 3	B30C-2500-551-WT	B-551		2.500 (63.5)	50ft. (15.2m)	1 roll (cont.)		B30-R10000
Fig. 3	B30C-3250-551-WT	B-551		3.250 (82.6)	50ft. (15.2m)	1 roll (cont.)		B30-R10000
Fig. 3	B30C-4250-551-WT	B-551		4.250 (107.9)	50ft. (15.2m)	1 roll (cont.)		B30-R10000

All part numbers above are compatible with BradyPrinter i3300 and BBP®33. Parts may also be compatible with BradyPrinter S3000, BradyPrinter S3100, BBP®30, BBP®31, BBP®35 and BBP®37 printers. Visit BradyID.com to confirm compatibility.

Indoor and Outdoor Vinyl (B-595)

- For general facility and safety identification
- Durable, low-shrink vinyl with our most aggressive adhesive
- Conforms to irregular, curved, rough and highly textured surfaces (painted cinder blocks, uneven wood, textured plastics, paper-jacketed pipes, powder-coated surfaces)
- Adheres to “difficult” low-surface energy items (PVC piping, blow-molded equipment cases, ABS plastics, recycled plastics)

Service temp: -40°F to 180°F
 Application temp: 0°F to 180°F
 Average outdoor durability: 8-10 years
 Agency approvals: RoHS

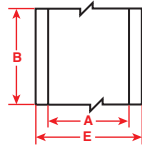

Figure 3



Facility and Safety Applications

- Lean / 5S Labels
- Pipe Markers
- Safety and Warning Labels
- Equipment and Panel Labels
- Arc Flash and Chemical Labels
- And more

Diagram	Catalog #	B#	Color	Label Width A Inch (mm)	Roll Length B Feet (m)	Labels Per Roll	Rec. Ribbon
Fig. 3	B30C-500-595-WT	B-595	White	0.500 (12.7)	100 (30.5)	1 roll (cont.)	B30-R10000
Fig. 3	B30C-1125-595-WT	B-595	White	1.125 (28.6)	100 (30.5)	1 roll (cont.)	B30-R10000
Fig. 3	B30C-2250-595-WT	B-595	White	2.250 (57.5)	100 (30.5)	1 roll (cont.)	B30-R10000
Fig. 3	B30C-3000-595-WT	B-595	White	3.000 (76.2)	100 (30.5)	1 roll (cont.)	B30-R10000
Fig. 3	B30C-4000-595-WT	B-595	White	4.000 (101.6)	100 (30.5)	1 roll (cont.)	B30-R10000
Fig. 3	B30C-500-595-YL	B-595	Yellow	0.500 (12.7)	100 (30.5)	1 roll (cont.)	B30-R10000
Fig. 3	B30C-1125-595-YL	B-595	Yellow	1.125 (28.6)	100 (30.5)	1 roll (cont.)	B30-R10000
Fig. 3	B30C-2250-595-YL	B-595	Yellow	2.250 (57.5)	100 (30.5)	1 roll (cont.)	B30-R10000
Fig. 3	B30C-3000-595-YL	B-595	Yellow	3.000 (76.2)	100 (30.5)	1 roll (cont.)	B30-R10000
Fig. 3	B30C-4000-595-YL	B-595	Yellow	4.000 (101.6)	100 (30.5)	1 roll (cont.)	B30-R10000
Fig. 3	B30C-500-595-RD	B-595	Red	0.500 (12.7)	100 (30.5)	1 roll (cont.)	B30-R10000-WT
Fig. 3	B30C-1125-595-RD	B-595	Red	1.125 (28.6)	100 (30.5)	1 roll (cont.)	B30-R10000-WT
Fig. 3	B30C-2250-595-RD	B-595	Red	2.250 (57.5)	100 (30.5)	1 roll (cont.)	B30-R10000-WT
Fig. 3	B30C-4000-595-RD	B-595	Red	4.000 (101.6)	100 (30.5)	1 roll (cont.)	B30-R10000-WT
Fig. 3	B30C-500-595-BL	B-595	Blue	0.500 (12.7)	100 (30.5)	1 roll (cont.)	B30-R10000-WT
Fig. 3	B30C-1125-595-BL	B-595	Blue	1.125 (28.6)	100 (30.5)	1 roll (cont.)	B30-R10000-WT
Fig. 3	B30C-2250-595-BL	B-595	Blue	2.250 (57.5)	100 (30.5)	1 roll (cont.)	B30-R10000-WT
Fig. 3	B30C-4000-595-BL	B-595	Blue	4.000 (101.6)	100 (30.5)	1 roll (cont.)	B30-R10000-WT
Fig. 3	B30C-500-595-GN	B-595	Green	0.500 (12.7)	100 (30.5)	1 roll (cont.)	B30-R10000-WT
Fig. 3	B30C-1125-595-GN	B-595	Green	1.125 (28.6)	100 (30.5)	1 roll (cont.)	B30-R10000-WT
Fig. 3	B30C-2250-595-GN	B-595	Green	2.250 (57.5)	100 (30.5)	1 roll (cont.)	B30-R10000-WT
Fig. 3	B30C-4000-595-GN	B-595	Green	4.000 (101.6)	100 (30.5)	1 roll (cont.)	B30-R10000-WT
Fig. 3	B30C-500-595-OR	B-595	Orange	0.500 (12.7)	100 (30.5)	1 roll (cont.)	B30-R10000
Fig. 3	B30C-1125-595-OR	B-595	Orange	1.125 (28.6)	100 (30.5)	1 roll (cont.)	B30-R10000
Fig. 3	B30C-2250-595-OR	B-595	Orange	2.250 (57.5)	100 (30.5)	1 roll (cont.)	B30-R10000
Fig. 3	B30C-4000-595-OR	B-595	Orange	4.000 (101.6)	100 (30.5)	1 roll (cont.)	B30-R10000
Fig. 3	B30C-500-595-BK	B-595	Black	0.500 (12.7)	100 (30.5)	1 roll (cont.)	B30-R10000-WT
Fig. 3	B30C-1125-595-BK	B-595	Black	1.125 (28.6)	100 (30.5)	1 roll (cont.)	B30-R10000-WT
Fig. 3	B30C-2250-595-BK	B-595	Black	2.250 (57.5)	100 (30.5)	1 roll (cont.)	B30-R10000-WT
Fig. 3	B30C-4000-595-BK	B-595	Black	4.000 (101.6)	100 (30.5)	1 roll (cont.)	B30-R10000-WT
Fig. 3	B30C-500-595-BR	B-595	Brown	0.500 (12.7)	100 (30.5)	1 roll (cont.)	B30-R10000-WT
Fig. 3	B30C-1125-595-BR	B-595	Brown	1.125 (28.6)	100 (30.5)	1 roll (cont.)	B30-R10000-WT
Fig. 3	B30C-2250-595-BR	B-595	Brown	2.250 (57.5)	100 (30.5)	1 roll (cont.)	B30-R10000-WT
Fig. 3	B30C-4000-595-BR	B-595	Brown	4.000 (101.6)	100 (30.5)	1 roll (cont.)	B30-R10000-WT
Fig. 3	B30C-500-595-GD	B-595	Gold	0.500 (12.7)	100 (30.5)	1 roll (cont.)	B30-R10000
Fig. 3	B30C-1125-595-GD	B-595	Gold	1.125 (28.6)	100 (30.5)	1 roll (cont.)	B30-R10000
Fig. 3	B30C-2250-595-GD	B-595	Gold	2.250 (57.5)	100 (30.5)	1 roll (cont.)	B30-R10000
Fig. 3	B30C-4000-595-GD	B-595	Gold	4.000 (101.6)	100 (30.5)	1 roll (cont.)	B30-R10000
Fig. 3	B30C-500-595-GY	B-595	Gray	0.500 (12.7)	100 (30.5)	1 roll (cont.)	B30-R10000
Fig. 3	B30C-1125-595-GY	B-595	Gray	1.125 (28.6)	100 (30.5)	1 roll (cont.)	B30-R10000
Fig. 3	B30C-2250-595-GY	B-595	Gray	2.250 (57.5)	100 (30.5)	1 roll (cont.)	B30-R10000
Fig. 3	B30C-4000-595-GY	B-595	Gray	4.000 (101.6)	100 (30.5)	1 roll (cont.)	B30-R10000
Fig. 3	B30C-500-595-PL	B-595	Purple	0.500 (12.7)	100 (30.5)	1 roll (cont.)	B30-R10000-WT
Fig. 3	B30C-1125-595-PL	B-595	Purple	1.125 (28.6)	100 (30.5)	1 roll (cont.)	B30-R10000-WT
Fig. 3	B30C-2250-595-PL	B-595	Purple	2.250 (57.5)	100 (30.5)	1 roll (cont.)	B30-R10000-WT
Fig. 3	B30C-4000-595-PL	B-595	Purple	4.000 (101.6)	100 (30.5)	1 roll (cont.)	B30-R10000-WT
Fig. 3	B30C-500-595-CL	B-595	Clear	0.500 (12.7)	100 (30.5)	1 roll (cont.)	B30-R10000
Fig. 3	B30C-1125-595-CL	B-595	Clear	1.125 (28.6)	100 (30.5)	1 roll (cont.)	B30-R10000
Fig. 3	B30C-2250-595-CL	B-595	Clear	2.250 (57.5)	100 (30.5)	1 roll (cont.)	B30-R10000
Fig. 3	B30C-4000-595-CL	B-595	Clear	4.000 (101.6)	100 (30.5)	1 roll (cont.)	B30-R10000

U.S. Patent Nos. 5,823,689; 6,570,602. Additional Patents Pending.

All part numbers above are compatible with BradyPrinter i3300 and BBP®33. Parts may also be compatible with BradyPrinter S3000, BradyPrinter S3100, BBP®30, BBP®31, BBP®35 and BBP®37 printers. Visit BradyID.com to confirm compatibility.

Low-Halide Polyester (B-569)

- Low-halide content for labeling stainless steel pipes and surfaces. Applies best to very smooth surfaces and ideal for mounting to rigid panels

Service temp: -40°F to 212°F

Application temp: 0°F to 212°F

Average outdoor durability: 3-5 years

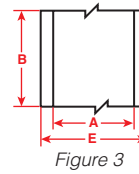

Diagram	Catalog #	B#	Color	Label Width A Inch (mm)	Roll Length B Feet (m)	Labels Per Roll	Rec. Ribbon
Fig. 3	B30C-500-569-WT	B-569	White	0.500 (12.7)	100 (30.5)	1 roll (cont.)	B30-R10000
Fig. 3	B30C-1125-569-WT	B-569	White	1.125 (28.6)	100 (30.5)	1 roll (cont.)	B30-R10000
Fig. 3	B30C-2250-569-WT	B-569	White	2.250 (57.5)	100 (30.5)	1 roll (cont.)	B30-R10000
Fig. 3	B30C-3000-569-WT	B-569	White	3.000 (76.2)	100 (30.5)	1 roll (cont.)	B30-R10000
Fig. 3	B30C-4000-569-WT	B-569	White	4.000 (101.6)	100 (30.5)	1 roll (cont.)	B30-R10000
Fig. 3	B30C-500-569-YL	B-569	Yellow	0.500 (12.7)	100 (30.5)	1 roll (cont.)	B30-R10000
Fig. 3	B30C-1125-569-YL	B-569	Yellow	1.125 (28.6)	100 (30.5)	1 roll (cont.)	B30-R10000
Fig. 3	B30C-2250-569-YL	B-569	Yellow	2.250 (57.5)	100 (30.5)	1 roll (cont.)	B30-R10000
Fig. 3	B30C-4000-569-YL	B-569	Yellow	4.000 (101.6)	100 (30.5)	1 roll (cont.)	B30-R10000
Fig. 3	B30C-500-569-RD	B-569	Red	0.500 (12.7)	100 (30.5)	1 roll (cont.)	B30-R10000-WT
Fig. 3	B30C-1125-569-RD	B-569	Red	1.125 (28.6)	100 (30.5)	1 roll (cont.)	B30-R10000-WT
Fig. 3	B30C-2250-569-RD	B-569	Red	2.250 (57.5)	100 (30.5)	1 roll (cont.)	B30-R10000-WT
Fig. 3	B30C-4000-569-RD	B-569	Red	4.000 (101.6)	100 (30.5)	1 roll (cont.)	B30-R10000-WT
Fig. 3	B30C-500-569-BL	B-569	Blue	0.500 (12.7)	100 (30.5)	1 roll (cont.)	B30-R10000-WT
Fig. 3	B30C-1125-569-BL	B-569	Blue	1.125 (28.6)	100 (30.5)	1 roll (cont.)	B30-R10000-WT
Fig. 3	B30C-2250-569-BL	B-569	Blue	2.250 (57.5)	100 (30.5)	1 roll (cont.)	B30-R10000-WT
Fig. 3	B30C-4000-569-BL	B-569	Blue	4.000 (101.6)	100 (30.5)	1 roll (cont.)	B30-R10000-WT
Fig. 3	B30C-500-569-LB	B-569	Light Blue	0.500 (12.7)	100 (30.5)	1 roll (cont.)	B30-R10000
Fig. 3	B30C-1125-569-LB	B-569	Light Blue	1.125 (28.6)	100 (30.5)	1 roll (cont.)	B30-R10000
Fig. 3	B30C-2250-569-LB	B-569	Light Blue	2.250 (57.5)	100 (30.5)	1 roll (cont.)	B30-R10000
Fig. 3	B30C-4000-569-LB	B-569	Light Blue	4.000 (101.6)	100 (30.5)	1 roll (cont.)	B30-R10000
Fig. 3	B30C-500-569-SB	B-569	Sky Blue	0.500 (12.7)	100 (30.5)	1 roll (cont.)	B30-R10000
Fig. 3	B30C-1125-569-SB	B-569	Sky Blue	1.125 (28.6)	100 (30.5)	1 roll (cont.)	B30-R10000
Fig. 3	B30C-2250-569-SB	B-569	Sky Blue	2.250 (57.5)	100 (30.5)	1 roll (cont.)	B30-R10000
Fig. 3	B30C-4000-569-SB	B-569	Sky Blue	4.000 (101.6)	100 (30.5)	1 roll (cont.)	B30-R10000
Fig. 3	B30C-500-569-GN	B-569	Green	0.500 (12.7)	100 (30.5)	1 roll (cont.)	B30-R10000-WT
Fig. 3	B30C-1125-569-GN	B-569	Green	1.125 (28.6)	100 (30.5)	1 roll (cont.)	B30-R10000-WT
Fig. 3	B30C-2250-569-GN	B-569	Green	2.250 (57.5)	100 (30.5)	1 roll (cont.)	B30-R10000-WT
Fig. 3	B30C-4000-569-GN	B-569	Green	4.000 (101.6)	100 (30.5)	1 roll (cont.)	B30-R10000-WT
Fig. 3	B30C-500-569-OR	B-569	Orange	0.500 (12.7)	100 (30.5)	1 roll (cont.)	B30-R10000
Fig. 3	B30C-1125-569-OR	B-569	Orange	1.125 (28.6)	100 (30.5)	1 roll (cont.)	B30-R10000
Fig. 3	B30C-2250-569-OR	B-569	Orange	2.250 (57.5)	100 (30.5)	1 roll (cont.)	B30-R10000
Fig. 3	B30C-4000-569-OR	B-569	Orange	4.000 (101.6)	100 (30.5)	1 roll (cont.)	B30-R10000
Fig. 3	B30C-500-569-BK	B-569	Black	0.500 (12.7)	100 (30.5)	1 roll (cont.)	B30-R10000-WT
Fig. 3	B30C-1125-569-BK	B-569	Black	1.125 (28.6)	100 (30.5)	1 roll (cont.)	B30-R10000-WT
Fig. 3	B30C-2250-569-BK	B-569	Black	2.250 (57.5)	100 (30.5)	1 roll (cont.)	B30-R10000-WT
Fig. 3	B30C-4000-569-BK	B-569	Black	4.000 (101.6)	100 (30.5)	1 roll (cont.)	B30-R10000-WT
Fig. 3	B30C-500-569-BR	B-569	Brown	0.500 (12.7)	100 (30.5)	1 roll (cont.)	B30-R10000-WT
Fig. 3	B30C-1125-569-BR	B-569	Brown	1.125 (28.6)	100 (30.5)	1 roll (cont.)	B30-R10000-WT
Fig. 3	B30C-2250-569-BR	B-569	Brown	2.250 (57.5)	100 (30.5)	1 roll (cont.)	B30-R10000-WT
Fig. 3	B30C-4000-569-BR	B-569	Brown	4.000 (101.6)	100 (30.5)	1 roll (cont.)	B30-R10000-WT
Fig. 3	B30C-500-569-OC	B-569	Ochre	0.500 (12.7)	100 (30.5)	1 roll (cont.)	B30-R10000
Fig. 3	B30C-1125-569-OC	B-569	Ochre	1.125 (28.6)	100 (30.5)	1 roll (cont.)	B30-R10000
Fig. 3	B30C-2250-569-OC	B-569	Ochre	2.250 (57.5)	100 (30.5)	1 roll (cont.)	B30-R10000
Fig. 3	B30C-4000-569-OC	B-569	Ochre	4.000 (101.6)	100 (30.5)	1 roll (cont.)	B30-R10000
Fig. 3	B30C-500-569-TN	B-569	Tan	0.500 (12.7)	100 (30.5)	1 roll (cont.)	B30-R10000
Fig. 3	B30C-1125-569-TN	B-569	Tan	1.125 (28.6)	100 (30.5)	1 roll (cont.)	B30-R10000
Fig. 3	B30C-2250-569-TN	B-569	Tan	2.250 (57.5)	100 (30.5)	1 roll (cont.)	B30-R10000
Fig. 3	B30C-4000-569-TN	B-569	Tan	4.000 (101.6)	100 (30.5)	1 roll (cont.)	B30-R10000
Fig. 3	B30C-500-569-GY	B-569	Gray	0.500 (12.7)	100 (30.5)	1 roll (cont.)	B30-R10000
Fig. 3	B30C-1125-569-GY	B-569	Gray	1.125 (28.6)	100 (30.5)	1 roll (cont.)	B30-R10000
Fig. 3	B30C-2250-569-GY	B-569	Gray	2.250 (57.5)	100 (30.5)	1 roll (cont.)	B30-R10000
Fig. 3	B30C-4000-569-GY	B-569	Gray	4.000 (101.6)	100 (30.5)	1 roll (cont.)	B30-R10000
Fig. 3	B30C-500-569-PL	B-569	Purple	0.500 (12.7)	100 (30.5)	1 roll (cont.)	B30-R10000-WT
Fig. 3	B30C-1125-569-PL	B-569	Purple	1.125 (28.6)	100 (30.5)	1 roll (cont.)	B30-R10000-WT
Fig. 3	B30C-2250-569-PL	B-569	Purple	2.250 (57.5)	100 (30.5)	1 roll (cont.)	B30-R10000-WT
Fig. 3	B30C-4000-569-PL	B-569	Purple	4.000 (101.6)	100 (30.5)	1 roll (cont.)	B30-R10000-WT
Fig. 3	B30C-500-569-PK	B-569	Pink	0.500 (12.7)	100 (30.5)	1 roll (cont.)	B30-R10000
Fig. 3	B30C-1125-569-PK	B-569	Pink	1.125 (28.6)	100 (30.5)	1 roll (cont.)	B30-R10000
Fig. 3	B30C-2250-569-PK	B-569	Pink	2.250 (57.5)	100 (30.5)	1 roll (cont.)	B30-R10000
Fig. 3	B30C-4000-569-PK	B-569	Pink	4.000 (101.6)	100 (30.5)	1 roll (cont.)	B30-R10000
Fig. 3	B30C-500-569-CL	B-569	Clear	0.500 (12.7)	100 (30.5)	1 roll (cont.)	B30-R10000
Fig. 3	B30C-1125-569-CL	B-569	Clear	1.125 (28.6)	100 (30.5)	1 roll (cont.)	B30-R10000
Fig. 3	B30C-2250-569-CL	B-569	Clear	2.250 (57.5)	100 (30.5)	1 roll (cont.)	B30-R10000
Fig. 3	B30C-4000-569-CL	B-569	Clear	4.000 (101.6)	100 (30.5)	1 roll (cont.)	B30-R10000

All part numbers above are compatible with BradyPrinter i3300 and BBP®33. Parts may also be compatible with BradyPrinter S3000, BradyPrinter S3100, BBP®30, BBP®31, BBP®35 and BBP®37 printers. Visit BradyID.com to confirm compatibility.

ToughWash® Washdown Resistant Labels (B-854 and B-855)

- Withstands high pressure, heat, harsh chemicals and numerous washdown cycles
- Legible and long-lasting for even the toughest washdown cycles
- Ideal for use in the food and beverage industry
- B-854 offers metal detectable layer to allow detection in food stream

Service temp: -40°F to 230°F
Agency approvals: RoHS

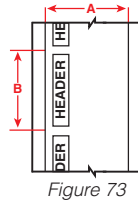
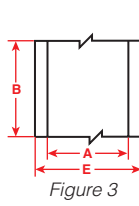





Diagram	Catalog #	B#	Color	Label Width A Inch (mm)	Length B Inch (mm)	Labels Per Roll	Rec. Ribbon
ToughWash Metal Detectable Material (B-854):							
Fig. 3	B30C-4000-854-YL	B-854		4.000 (101.06)	50 ft. (15.2 m)	1 roll (cont.)	B30-R6000
Fig. 3	B30C-4000-854-WT	B-854		4.000 (101.06)	50 ft. (15.2 m)	1 roll (cont.)	B30-R6000
Fig. 73	B30-25-854-OSHADADA	B-854		4.000 (101.06)	6.250 (158.8)	100	B30-R6000
Fig. 73	B30-25-854-ANSIWA	B-854		4.000 (101.06)	6.250 (158.8)	100	B30-R6000
Fig. 73	B30-25-854-ANSIDA	B-854		4.000 (101.06)	6.250 (158.8)	100	B30-R6000
Fig. 73	B30-25-854-ANSICA	B-854		4.000 (101.06)	6.250 (158.8)	100	B30-R6000
Fig. 73	B30-25-854-PEL	B-854		4.000 (101.06)	6.250 (158.8)	100	B30-R6000
Fig. 73	B30-25-854-PREC	B-854		4.000 (101.06)	6.250 (158.8)	100	B30-R6000
ToughWash Material (B-855):							
Fig. 3	B30C-1125-855-YL	B-855		1.125 (28.6)	50 ft. (15.2 m)	1 roll (cont.)	B30-R6000
Fig. 3	B30C-2250-855-YL	B-855		2.250 (57.5)	50 ft. (15.2 m)	1 roll (cont.)	B30-R6000
Fig. 3	B30C-4000-855-YL	B-855		4.000 (101.06)	50 ft. (15.2 m)	1 roll (cont.)	B30-R6000
Fig. 3	B30C-1125-855-WT	B-855		1.125 (28.6)	50 ft. (15.2 m)	1 roll (cont.)	B30-R6000
Fig. 3	B30C-2250-855-WT	B-855		2.250 (57.5)	50 ft. (15.2 m)	1 roll (cont.)	B30-R6000
Fig. 3	B30C-4000-855-WT	B-855		4.000 (101.06)	50 ft. (15.2 m)	1 roll (cont.)	B30-R6000
Fig. 73	B30-25-855-OSHADADA	B-855		4.000 (101.06)	6.250 (158.8)	100	B30-R6000
Fig. 73	B30-25-855-ANSIWA	B-855		4.000 (101.06)	6.250 (158.8)	100	B30-R6000
Fig. 73	B30-25-855-ANSIDA	B-855		4.000 (101.06)	6.250 (158.8)	100	B30-R6000
Fig. 73	B30-25-855-ANSICA	B-855		4.000 (101.06)	6.250 (158.8)	100	B30-R6000
Fig. 73	B30-25-855-PEL	B-855		4.000 (101.06)	6.250 (158.8)	100	B30-R6000
Fig. 73	B30-25-855-PREC	B-855		4.000 (101.06)	6.250 (158.8)	100	B30-R6000

All part numbers above are compatible with BradyPrinter i3300 and BBP®33. Parts may also be compatible with BradyPrinter S3000, BradyPrinter S3100, BBP®30, BBP®31, BBP®35 and BBP®37 printers. Visit BradyID.com to confirm compatibility.

Chemical and Solvent Resistant Polypropylene Labels (B-425, B-7425)

- Outstanding chemical and solvent resistance and print performance
- Not recommended for prolonged outdoor use

B-425: Service temp: -94°F to 212°F
B-7425: Service temp: -320°F to 248°F
 Agency approvals:    

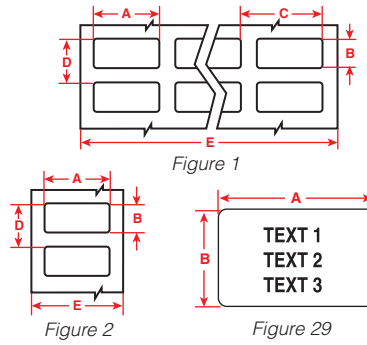

Diagram	Catalog #	B#	Color	Label Width A Inch (mm)	Label Height B Inch (mm)	Horiz. Repeat C Inch (mm)	Vert. Repeat D Inch (mm)	Web Width E Inch (mm)	Labels Per Row	Labels Per Roll	Rec. Ribbon
Fig. 1	B33-5-425	B-425	White	1.000 (25.4)	0.500 (12.7)	1.075 (27.3)	0.600 (15.2)	3.350 (85.1)	3	5000	B30-R4300
Fig. 2	B33-17-425	B-425	White	2.000 (50.8)	1.000 (25.4)	—	1.125 (28.6)	2.200 (55.9)	1	1500	B30-R4300
Fig. 2	B33-18-425	B-425	White	3.000 (76.2)	1.000 (25.4)	—	1.125 (28.6)	3.200 (81.3)	1	1500	B30-R4300
Fig. 2	B33-19-425	B-425	White	3.000 (76.2)	2.000 (50.8)	—	2.125 (54.0)	3.200 (81.3)	1	500	B30-R4300
Fig. 29	B33-88-7425	B-7425	White	1.000 (25.4)	0.750 (19.1)	—	—	—	2	2000	B30-R4300
Fig. 29	B33-179-7425	B-7425	White	1.000 (25.4)	1.000 (25.4)	—	—	—	1	1500	B30-R4300
Fig. 29	B33-37-7425	B-7425	White	1.500 (38.1)	0.500 (12.7)	—	—	—	2	1500	B30-R4300
Fig. 29	B33-136-7425	B-7425	White	1.500 (38.1)	0.750 (19.1)	—	—	—	1	1500	B30-R4300
Fig. 29	B33-235-7425	B-7425	White	1.500 (38.1)	1.000 (25.4)	—	—	—	1	1250	B30-R4300
Fig. 29	B33-258-7425	B-7425	White	1.500 (38.1)	1.750 (44.5)	—	—	—	1	900	B30-R4300
Fig. 29	B33-53-7425	B-7425	White	2.000 (50.8)	0.500 (12.7)	—	—	—	1	2000	B30-R4300

Retro Reflective Tape (B-584)

- Highly reflective material shines back brightly when struck by light
- Ideal for labeling outdoor utility pedestals, hard hats, jobsite equipment and roof-top equipment
- Recommended for low light or inclement weather conditions

Service temp: -40°F to 158°F
 Application temp: 0°F to 158°F (yellow and orange), 50°F to 158°F (silver)
 Average outdoor durability: 4 to 6 years

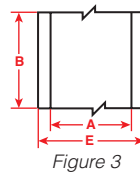

Diagram	Catalog #	B#	Color	Label Width A Inch (mm)	Roll Length B Feet (m)	Labels Per Roll	Rec. Ribbon
Fig. 3	B30C-1125-584-SL	B-584	Silver	1.125 (28.6)	50 (15.2)	1 roll (cont.)	B30-R10000
Fig. 3	B30C-2250-584-SL	B-584	Silver	2.250 (57.5)	50 (15.2)	1 roll (cont.)	B30-R10000
Fig. 3	B30C-4000-584-SL	B-584	Silver	4.000 (101.6)	50 (15.2)	1 roll (cont.)	B30-R10000
Fig. 3	B30C-1125-584-YL	B-584	Yellow	1.125 (28.6)	50 (15.2)	1 roll (cont.)	B30-R10000
Fig. 3	B30C-2250-584-YL	B-584	Yellow	2.250 (57.5)	50 (15.2)	1 roll (cont.)	B30-R10000
Fig. 3	B30C-4000-584-YL	B-584	Yellow	4.000 (101.6)	50 (15.2)	1 roll (cont.)	B30-R10000
Fig. 3	B30C-1125-584-OR	B-584	Orange	1.125 (28.6)	50 (15.2)	1 roll (cont.)	B30-R10000
Fig. 3	B30C-2250-584-OR	B-584	Orange	2.250 (57.5)	50 (15.2)	1 roll (cont.)	B30-R10000
Fig. 3	B30C-4000-584-OR	B-584	Orange	4.000 (101.6)	50 (15.2)	1 roll (cont.)	B30-R10000

BradyGlo™ High-Intensity Photoluminescent Tape (B-526)

- For glow-in-the-dark identification up to 10 hours
- Designed for directional, evacuation and equipment marking. Ideal for marking emergency utility shut-offs, fire extinguishers, alarm pulls and vital equipment controls
- Complies with indoor use requirements specified in RS 6-1 and 6-1A of New York Local Law 26

Service temp: -40°F to 140°F
 Application temp: 40°F to 140°F

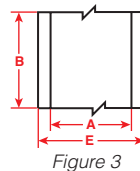

Diagram	Catalog #	B#	Color	Label Width A Inch (mm)	Roll Length B Feet (m)	Labels Per Roll	Rec. Ribbon
Fig. 3	B30C-1125-526	B-526	Luminous Green	1.125 (28.6)	50 (15.2)	1 roll (cont.)	B30-R10000
Fig. 3	B30C-2250-526	B-526	Luminous Green	2.250 (57.5)	50 (15.2)	1 roll (cont.)	B30-R10000
Fig. 3	B30C-4000-526	B-526	Luminous Green	4.000 (101.6)	50 (15.2)	1 roll (cont.)	B30-R10000

All part numbers above are compatible with BradyPrinter i3300 and BBP®33. Parts may also be compatible with BradyPrinter S3000, BradyPrinter S3100, BBP®30, BBP®31, BBP®35 and BBP®37 printers. Visit BradyID.com to confirm compatibility.

Printable Magnetic Supply (B-509)

- Easiest and quickest material for removing and repositioning
- Non-adhesive magnetic material that can be printed on directly
- Ideal for reusable, repositionable and Lean / 5S identification applications

Service temp: 0°F to 158°F
Average outdoor durability: 3 to 5 years

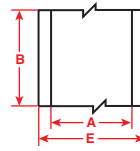

Figure 3



Diagram	Catalog #	B#	Color	Label Width A Inch (mm)	Roll Length B Feet (m)	Labels Per Roll	Rec. Ribbon
Fig. 3	B30C-2500-509-WT	B-509	White	2.500 (63.5)	25 (7.62)	1 roll (cont.)	B30-R10000
Fig. 3	B30C-4250-509-WT	B-509	White	4.250 (107.8)	25 (7.62)	1 roll (cont.)	B30-R10000
Fig. 3	B30C-2500-509-YL	B-509	Yellow	2.500 (63.5)	25 (7.62)	1 roll (cont.)	B30-R10000
Fig. 3	B30C-4250-509-YL	B-509	Yellow	4.250 (107.8)	25 (7.62)	1 roll (cont.)	B30-R10000

Repositionable Vinyl (B-581)

- Aggressive adhesive stays in place but removes cleanly without leaving adhesive residue
- Ideal for temporary, removable and repositionable labels, such as Lean / 5S inventory labels

Service temp: -40°F to 180°F
Application temp: 50°F to 180°F
Average outdoor durability: 5 years

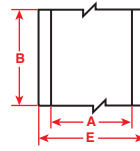

Figure 3



Diagram	Catalog #	B#	Color	Label Width A Inch (mm)	Roll Length B Feet (m)	Labels Per Roll	Rec. Ribbon
Fig. 3	B30C-500-581-WT	B-581	White	0.500 (12.7)	100 (30.5)	1 roll (cont.)	B30-R10000
Fig. 3	B30C-1125-581-WT	B-581	White	1.125 (28.6)	100 (30.5)	1 roll (cont.)	B30-R10000
Fig. 3	B30C-2250-581-WT	B-581	White	2.250 (57.5)	100 (30.5)	1 roll (cont.)	B30-R10000
Fig. 3	B30C-4000-581-WT	B-581	White	4.000 (101.6)	100 (30.5)	1 roll (cont.)	B30-R10000
Fig. 3	B30C-500-581-YL	B-581	Yellow	0.500 (12.7)	100 (30.5)	1 roll (cont.)	B30-R10000
Fig. 3	B30C-1125-581-YL	B-581	Yellow	1.125 (28.6)	100 (30.5)	1 roll (cont.)	B30-R10000
Fig. 3	B30C-2250-581-YL	B-581	Yellow	2.250 (57.5)	100 (30.5)	1 roll (cont.)	B30-R10000
Fig. 3	B30C-4000-581-YL	B-581	Yellow	4.000 (101.6)	100 (30.5)	1 roll (cont.)	B30-R10000

Dissolvable Paper Labels (B-403)

- Designed for temporary applications where easy removal, re-identification or waste reduction are valued
- Ideal for labeling vials, tubes or general glassware, temporary asset tracking, animal housing identification, and general use
- Completely dissolves in warm water within 30 seconds, leaving no adhesive residue

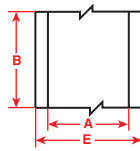

Figure 3

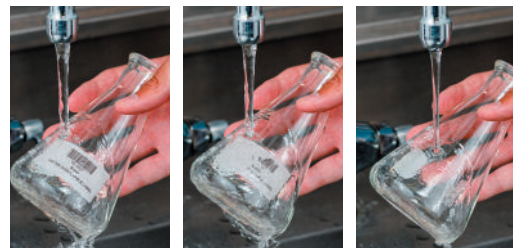

Diagram	Catalog #	B#	Color	Label Width A Inch (mm)	Roll Length B Inch (mm)	Labels Per Roll	Rec. Ribbon
Fig. 3	B30C-1125-403-WT	B-403	White	1.125 (28.575)	100 (30.5)	1 (cont.)	B30-R4300
Fig. 3	B30C-2250-403-WT	B-403	White	2.250 (57.15)	100 (30.5)	1 (cont.)	B30-R4300
Fig. 3	B30C-3000-403-WT	B-403	White	3.000 (76.2)	100 (30.5)	1 (cont.)	B30-R4300
Fig. 3	B30C-4000-403-WT	B-403	White	4.000 (101.6)	100 (30.5)	1 (cont.)	B30-R4300

All part numbers above are compatible with BradyPrinter i3300 and BBP®33. Parts may also be compatible with BradyPrinter S3000, BradyPrinter S3100, BBP®30, BBP®31, BBP®35 and BBP®37 printers. Visit BradyID.com to confirm compatibility.

Pre-Printed GHS / CLP Chemical Labels (B-569 and B-7569)

- Blank labels with pre-printed red diamonds allow the printer to produce 2-color GHS / CLP labels in one print pass
- 3 sizes of labels, each with 6 diamond layouts that match templates in the printer app (if applicable) or in the Brady Workstation GHS App
- Indoor / outdoor vinyl material and durable inks withstand exposure to moisture, chemicals and handling

Service temp: -4°F to 180°F
 Application temp: 50°F to 180°F
 Average outdoor durability: 3-5 years



Catalog #	B#	Material	Legend		Label Height Inch (mm)	Label Width Inch (mm)	Labels Per Row	Labels Per Roll	Rec. Ribbon
B30-260-7569-CLP1	B-7569	Vinyl		L1 Diamond + Text	2.170 (55.0)	3.350 (85.0)	1	340	B30-R10000
B30-261-7569-CLP1	B-7569	Vinyl		L1 Diamond + Text	2.950 (75.0)	4.330 (110.0)	1	270	B30-R10000
B30-262-7569-CLP1	B-7569	Vinyl		L1 Diamond + Text	4.130 (105.0)	6.100 (155.0)	1	200	B30-R10000
B30-260-7569-CLP2	B-7569	Vinyl		L2 Diamond + Text	2.170 (55.0)	3.350 (85.0)	1	340	B30-R10000
B30-261-7569-CLP2	B-7569	Vinyl		L2 Diamond + Text	2.950 (75.0)	4.330 (110.0)	1	270	B30-R10000
B30-262-7569-CLP2	B-7569	Vinyl		L2 Diamond + Text	4.130 (105.0)	6.100 (155.0)	1	200	B30-R10000
B30-260-7569-CLP3A	B-7569	Vinyl		L3A Diamond + Text	2.170 (55.0)	3.350 (85.0)	1	340	B30-R10000
B30-261-7569-CLP3A	B-7569	Vinyl		L3A Diamond + Text	2.950 (75.0)	4.330 (110.0)	1	270	B30-R10000
B30-262-7569-CLP3A	B-7569	Vinyl		L3A Diamond + Text	4.130 (105.0)	6.100 (155.0)	1	200	B30-R10000
B30-260-7569-CLP3B	B-7569	Vinyl		L3B Diamond + Text	2.170 (55.0)	3.350 (85.0)	1	340	B30-R10000
B30-261-7569-CLP3B	B-7569	Vinyl		L3B Diamond + Text	2.950 (75.0)	4.330 (110.0)	1	270	B30-R10000
B30-262-7569-CLP3B	B-7569	Vinyl		L3B Diamond + Text	4.130 (105.0)	6.100 (155.0)	1	200	B30-R10000
B30-260-7569-CLP4A	B-7569	Vinyl		L4A Diamond + Text	2.170 (55.0)	3.350 (85.0)	1	340	B30-R10000
B30-261-7569-CLP4A	B-7569	Vinyl		L4A Diamond + Text	2.950 (75.0)	4.330 (110.0)	1	270	B30-R10000
B30-262-7569-CLP4A	B-7569	Vinyl		L4A Diamond + Text	4.130 (105.0)	6.100 (155.0)	1	200	B30-R10000
B30-260-569-CLP4B	B-569	Polyester		L4B Diamond + Text	2.170 (55.0)	3.350 (85.0)	1	340	B30-R10000
B30-260-7569-CLP4B	B-7569	Vinyl		L4B Diamond + Text	2.170 (55.0)	3.350 (85.0)	1	340	B30-R10000
B30-261-569-CLP4B	B-569	Polyester		L4B Diamond + Text	2.950 (75.0)	4.330 (110.0)	1	270	B30-R10000
B30-261-7569-CLP4B	B-7569	Vinyl		L4B Diamond + Text	2.950 (75.0)	4.330 (110.0)	1	270	B30-R10000
B30-262-569-CLP4B	B-569	Polyester		L4B Diamond + Text	4.130 (105.0)	6.100 (155.0)	1	200	B30-R10000
B30-262-7569-CLP4B	B-7569	Vinyl		L4B Diamond + Text	4.130 (105.0)	6.100 (155.0)	1	200	B30-R10000
B30-18-7569-CLP4C	B-7569	Vinyl		L4C Diamond + Text	1.000 (25.4)	3.000 (76.2)	1	1000	B30-R10000

▶ Easily create your GHS labels with Brady Workstation GHS App













- Use built-in pre-formatted label layouts with approved GHS symbols
- Search the built-in chemical database by CAS number to auto-populate your label, then edit to meet your specific SDS
- Print any of the six template sizes
- No driver required when using the BradyPrinter i3300



All part numbers above are compatible with BradyPrinter i3300 and BBP®33. Parts may also be compatible with BradyPrinter S3000, BradyPrinter S3100, BBP®30, BBP®31, BBP®35 and BBP®37 printers. Visit BradyID.com to confirm compatibility.

General ID Labels for Lean / 5S, Bins and Production Areas (B-483, B-484A, B-498, B-499 and B-595)

- Also ideal for marking backer board, DIN rail, relays, PLCs, switches, solenoids, drive motors and other components inside panels
- All recommended materials are flexible and have high-tack adhesives for adhesion to wide variety of surfaces and components

B-483: Service temp: -40°F to 248°F Agency approvals:   
B-484A: Service temp: -40°F to 240°F Agency approvals:   
B-498: Service temp: -40°F to 175°F Agency approvals:   
B-499: Service temp: -40°F to 193°F Agency approvals:   
B-595: Service temp: -40°F to 180°F Agency approvals: 
 8-10 years average outdoor durability

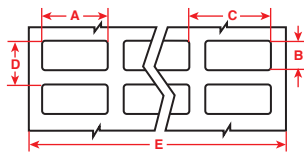

Figure 1

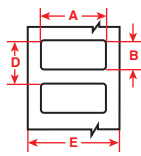

Figure 2

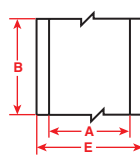

Figure 3





Diagram	Catalog #	B#	Color	Label Width A Inch (mm)	Label Height B Inch (mm)	Horiz. Repeat C Inch (mm)	Vert. Repeat D Inch (mm)	Web Width E Inch (mm)	Labels Per Row	Labels Per Roll	Rec. Ribbon
Vinyl Cloth - Aggressive but repositionable adhesive (B-498):											
Fig. 1	B33-90-498	B-498	White	0.250 (6.4)	1.437 (36.5)	0.350 (8.9)	1.562 (39.7)	2.200 (55.9)	6	2500	B30-R6200
Fig. 1	B33-68-498	B-498	White	0.500 (12.7)	0.750 (19.1)	0.600 (15.2)	0.875 (22.2)	2.500 (63.5)	4	5000	B30-R6200
Fig. 1	B33-87-498	B-498	White	0.500 (12.7)	1.437 (36.5)	0.600 (15.2)	1.562 (39.7)	3.700 (94.0)	6	2500	B30-R6200
Fig. 1	B33-1-498	B-498	White	0.750 (19.1)	0.250 (6.4)	0.800 (20.3)	0.350 (8.9)	3.350 (85.1)	4	5000	B30-R6200
Fig. 1	B33-95-498	B-498	White	0.800 (20.3)	1.437 (36.5)	0.900 (22.9)	1.562 (39.7)	2.800 (71.1)	3	2300	B30-R6200
Fig. 1	B33-5-498	B-498	White	1.000 (25.4)	0.500 (12.7)	1.075 (27.3)	0.600 (15.2)	3.350 (85.1)	3	5000	B30-R6200
Fig. 1	B33-88-498	B-498	White	1.000 (25.4)	0.750 (19.1)	1.100 (27.9)	0.875 (22.2)	2.300 (58.4)	2	2500	B30-R6200
Fig. 1	B33-89-498	B-498	White	1.000 (25.4)	1.437 (36.5)	1.100 (27.9)	1.562 (39.7)	3.400 (86.4)	3	2300	B30-R6200
Nylon Cloth - Permanent adhesive (B-499):											
Fig. 1	B33-68-499	B-499	White	0.500 (12.7)	0.750 (19.1)	0.600 (15.2)	0.875 (22.2)	2.500 (63.5)	4	1500	B30-R6000
Fig. 1	B33-165-499	B-499	White	0.800 (20.3)	1.437 (36.5)	0.900 (22.9)	1.562 (39.7)	3.700 (94.0)	4	2500	B30-R6000
Fig. 2	B33-125-499	B-499	White	0.900 (22.9)	0.500 (12.7)	-	-	-	1	1500	B30-R6000
Fig. 1	B33-126-499	B-499	White	0.900 (22.9)	0.500 (12.7)	-	-	-	2	1500	B30-R6000
Fig. 2	B33-163-499	B-499	White	1.000 (25.4)	0.375 (9.5)	-	-	-	1	1500	B30-R6000
Fig. 1	B33-152-499	B-499	White	1.000 (25.4)	0.375 (9.5)	-	-	-	2	1500	B30-R6000
Fig. 2	B33-136-499	B-499	White	1.500 (38.1)	0.750 (19.1)	-	0.875 (22.2)	1.770 (45.0)	1	1500	B30-R6000
Fig. 2	B33-137-499	B-499	White	2.000 (50.8)	1.000 (25.4)	-	1.125 (28.6)	2.200 (55.9)	1	1100	B30-R6000
Fig. 2	B33-125-499	B-499	White	2.000 (50.8)	0.250 (6.4)	-	-	-	1	1500	B30-R6000
Polyester - Ultra-aggressive adhesive for highly textured and low surface energy surfaces (B-483):											
Fig. 1	B33-149-483	B-483	White	0.500 (12.7)	0.500 (12.7)	0.600 (15.2)	0.600 (15.2)	2.500 (63.5)	4	5000	B30-R6000
Fig. 1	B33-5-483	B-483	White	1.000 (25.4)	0.500 (12.7)	1.075 (27.3)	0.600 (15.2)	3.350 (85.1)	3	5000	B30-R6000
Fig. 2	B33-17-483	B-483	White	2.000 (50.8)	1.000 (25.4)	-	1.125 (28.6)	2.200 (55.9)	1	1500	B30-R6000
Fig. 2	B33-7-483	B-483	White	2.750 (69.9)	1.250 (31.8)	-	1.375 (34.9)	2.950 (74.9)	1	1000	B30-R6000
Fig. 2	B33-18-483	B-483	White	3.000 (76.2)	1.000 (25.4)	-	1.125 (28.6)	3.200 (81.3)	1	1500	B30-R6000
Fig. 2	B33-19-483	B-483	White	3.000 (76.2)	2.000 (50.8)	-	2.125 (54.0)	3.200 (81.3)	1	500	B30-R6000
Fig. 2	B33-55-483	B-483	White	4.000 (101.6)	2.000 (50.8)	-	2.125 (54.0)	4.200 (106.7)	1	750	B30-R6000
Polyester - Ultra-aggressive adhesive and pliable for conforming to angular surfaces (B-484A):											
Fig. 2	B33-125-484	B-484A	White	0.900 (22.9)	0.500 (12.7)	-	0.600 (15.2)	1.100 (27.9)	1	1500	B30-R6000
Fig. 1	B33-5-484	B-484A	White	1.000 (25.4)	0.500 (12.7)	1.075 (27.3)	0.600 (15.2)	3.350 (85.1)	3	5000	B30-R6000
Fig. 2	B33-136-484	B-484A	White	1.500 (38.1)	0.750 (19.1)	-	0.875 (22.2)	1.700 (43.2)	1	1500	B30-R6000
Fig. 2	B33-17-484	B-484A	White	2.000 (50.8)	1.000 (25.4)	-	1.125 (28.6)	2.200 (55.9)	1	1500	B30-R6000
Fig. 2	B33-18-484	B-484A	White	3.000 (76.2)	1.000 (25.4)	-	1.125 (28.6)	3.200 (81.3)	1	1500	B30-R6000
Fig. 2	B33-19-484	B-484A	White	3.000 (76.2)	2.000 (50.8)	-	2.125 (54.0)	3.200 (81.3)	1	500	B30-R6000
Continuous cut-to-length vinyl - Permanent adhesive, conformable; indoor / outdoor grade (B-595*):											
Fig. 3	B30C-500-595-WT	B-595	White	0.500 (12.7)	100 ft. (30.5m)	-	-	0.700 (17.8)	1 roll (cont.)		B30-R10000
Fig. 3	B30C-1125-595-WT	B-595	White	1.125 (28.6)	100 ft. (30.5m)	-	-	1.375 (34.9)	1 roll (cont.)		B30-R10000
Fig. 3	B30C-500-595-YL	B-595	Yellow	0.500 (12.7)	100 ft. (30.5m)	-	-	0.700 (17.8)	1 roll (cont.)		B30-R10000
Fig. 3	B30C-1125-595-YL	B-595	Yellow	1.125 (28.6)	100 ft. (30.5m)	-	-	1.375 (34.9)	1 roll (cont.)		B30-R10000

* 46 additional sizes and colors available for B-595 (page 24)

All part numbers above are compatible with BradyPrinter i3300 and BBP®33. Parts may also be compatible with BradyPrinter S3000, BradyPrinter S3100, BBP®30, BBP®31, BBP®35 and BBP®37 printers. Visit BradyID.com to confirm compatibility.

ToughStripe® Printable Floor Marking Tape (B-483 with overlamine)

- Revolutionary B-483 material has ultra-aggressive adhesive
- Withstands forklift and pallet jack traffic without tearing or lifting
- Each roll ships with a roll of clear overlamine which must be applied over printed label and on to appropriate surface for best performance

Service temp: -40°F to 248°F
Agency approvals:  

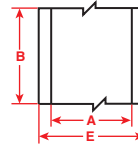

Figure 3



Diagram	Catalog #	B#	Color	Label Width A Inch (mm)	Roll Length B Feet (m)	Labels Per Roll	Rec. Ribbon
Fig. 3	B30C-1125-483WT-KT	B-483	White	1.125 (28.6)	100 (30.5)	1 roll (cont.)	B30-R6000
Fig. 3	B30C-2250-483WT-KT	B-483	White	2.250 (57.5)	100 (30.5)	1 roll (cont.)	B30-R6000
Fig. 3	B30C-3000-483WT-KT	B-483	White	3.000 (76.2)	100 (30.5)	1 roll (cont.)	B30-R6000
Fig. 3	B30C-4000-483WT-KT	B-483	White	4.000 (101.6)	100 (30.5)	1 roll (cont.)	B30-R6000
Fig. 3	B30C-1125-483YL-KT	B-483	Yellow	1.125 (28.6)	100 (30.5)	1 roll (cont.)	B30-R6000
Fig. 3	B30C-2250-483YL-KT	B-483	Yellow	2.250 (57.5)	100 (30.5)	1 roll (cont.)	B30-R6000
Fig. 3	B30C-3000-483YL-KT	B-483	Yellow	3.000 (76.2)	100 (30.5)	1 roll (cont.)	B30-R6000
Fig. 3	B30C-4000-483YL-KT	B-483	Yellow	4.000 (101.6)	100 (30.5)	1 roll (cont.)	B30-R6000
Fig. 3	B30C-1125-483RD-KT	B-483	Red	1.125 (28.6)	100 (30.5)	1 roll (cont.)	B30-R4400-WT
Fig. 3	B30C-2250-483RD-KT	B-483	Red	2.250 (57.5)	100 (30.5)	1 roll (cont.)	B30-R4400-WT
Fig. 3	B30C-4000-483RD-KT	B-483	Red	4.000 (101.6)	100 (30.5)	1 roll (cont.)	B30-R4400-WT
Fig. 3	B30C-1125-483BL-KT	B-483	Blue	1.125 (28.6)	100 (30.5)	1 roll (cont.)	B30-R4400-WT
Fig. 3	B30C-2250-483BL-KT	B-483	Blue	2.250 (57.5)	100 (30.5)	1 roll (cont.)	B30-R4400-WT
Fig. 3	B30C-4000-483BL-KT	B-483	Blue	4.000 (101.6)	100 (30.5)	1 roll (cont.)	B30-R4400-WT
Fig. 3	B30C-1125-483GN-KT	B-483	Green	1.125 (28.6)	100 (30.5)	1 roll (cont.)	B30-R4400-WT
Fig. 3	B30C-2250-483GN-KT	B-483	Green	2.250 (57.5)	100 (30.5)	1 roll (cont.)	B30-R4400-WT
Fig. 3	B30C-4000-483GN-KT	B-483	Green	4.000 (101.6)	100 (30.5)	1 roll (cont.)	B30-R4400-WT
Fig. 3	B30C-1125-483BK-KT	B-483	Black	1.125 (28.6)	100 (30.5)	1 roll (cont.)	B30-R4400-WT
Fig. 3	B30C-2250-483BK-KT	B-483	Black	2.250 (57.5)	100 (30.5)	1 roll (cont.)	B30-R4400-WT
Fig. 3	B30C-4000-483BK-KT	B-483	Black	4.000 (101.6)	100 (30.5)	1 roll (cont.)	B30-R4400-WT
Fig. 3	B30C-1125-483OR-KT	B-483	Orange	1.125 (28.6)	100 (30.5)	1 roll (cont.)	B30-R6000
Fig. 3	B30C-2250-483OR-KT	B-483	Orange	2.250 (57.5)	100 (30.5)	1 roll (cont.)	B30-R6000
Fig. 3	B30C-4000-483OR-KT	B-483	Orange	4.000 (101.6)	100 (30.5)	1 roll (cont.)	B30-R6000

ToughStripe part numbers above are compatible with BradyPrinter i3300, BradyPrinter S3000, BradyPrinter S3100, and BBP®35 and BBP®37 printers. ToughStripe material is not compatible with BBP®30, BBP®33 and BBP®31 printers.

Cold Temperature Application Material (B-549)

- Special adhesive permanently adheres to extremely cold surfaces
- Can be applied in -10°F and lasts in -40°F
- Ideal for cold storage warehouses, coolers, freezers and short-term winter outdoor use

Service temp: -40°F to 212°F
Application temp: -10°F to 212°F
Average outdoor durability: Up to 1 year

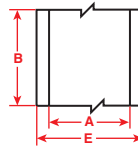

Figure 3



Diagram	Catalog #	B#	Color	Label Width A Inch (mm)	Roll Length B Feet (m)	Labels Per Roll	Rec. Ribbon
Fig. 3	B30C-1125-549-WT	B-549	White	1.125 (28.6)	100 (30.5)	1 roll (cont.)	B30-R10000
Fig. 3	B30C-2250-549-WT	B-549	White	2.250 (57.5)	100 (30.5)	1 roll (cont.)	B30-R10000
Fig. 3	B30C-4000-549-WT	B-549	White	4.000 (101.6)	100 (30.5)	1 roll (cont.)	B30-R10000
Fig. 3	B30C-1125-549-YL	B-549	Yellow	1.125 (28.6)	100 (30.5)	1 roll (cont.)	B30-R10000
Fig. 3	B30C-2250-549-YL	B-549	Yellow	2.250 (57.5)	100 (30.5)	1 roll (cont.)	B30-R10000
Fig. 3	B30C-4000-549-YL	B-549	Yellow	4.000 (101.6)	100 (30.5)	1 roll (cont.)	B30-R10000

All part numbers above are compatible with BradyPrinter i3300 and BBP®33. Parts may also be compatible with BradyPrinter S3000, BradyPrinter S3100, BBP®30, BBP®31, BBP®35 and BBP®37 printers. Visit BradyID.com to confirm compatibility.

Cryogenic Tube and Vial Labels (B-461, B-490, B-492 and B-7425)

FreezerBondz™ labels can be applied to room temperature or already frozen samples, with a small overlap. The label remains legible and will stick to the tube during processing, even when immersed in liquid or vapor phase nitrogen and ultra-low temperature freezer storage.

- **B-461 Self-Laminating Polyester:** Ultra-thin polyester label with clear overlaminated tail that protects print and allows liquid levels to be visible
- **B-490 Polyester:** White FreezerBondz label ideal for flat frozen surfaces. Adheres to frozen tubes and vials when wrapped around itself by at least 1/8".
- **B-492 Polyester:** FreezerBondz ultra-thin white polyester label for labeling of frosted/frozen or room temperature vials, tubes and canes. Superior chemical and abrasion resistance.
- **B-7425 Polypropylene:** Ideal for labeling dry, room temperature specimen containers. Material withstands temperature ranges from -196°C to 121°C (-320°F to 248°F). Chemical resistance to ethanol, DMSO, IPS, short-term xylene, 10% formalin, 50% acetic acid and toluene

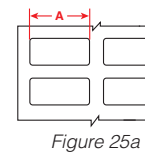
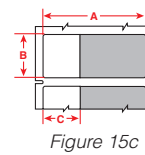
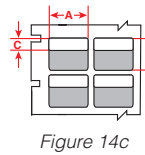
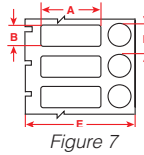
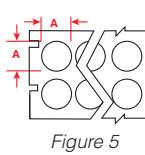
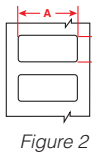

Diagram	Catalog #	B#	Color	Label Width A Inch (mm)	Label Height B Inch (mm)	Print-On Height C Inch (mm)	Labels Per Row	Labels Per Roll	Rec. Ribbon
Self-Laminating Polyester (B-461):									
Fig. 15c	B33-127-461	B-461	White	0.500 (12.7)	2.200 (55.9)	0.750 (19.1)	1	1500	B30-R4300
Fig. 15c	B33-133-461	B-461	White	0.600 (15.2)	1.625 (41.3)	1.000 (25.4)	1	1500	B30-R4300
Fig. 14c	B33-139-461	B-461	White	1.000 (25.4)	5.250 (133.4)	1.500 (38.1)	2	650	B30-R4300
Fig. 15c	B33-123-461	B-461	White	1.800 (45.7)	0.375 (9.5)	0.750 (19.1)	1	1500	B30-R4300
Fig. 15c	B33-122-461	B-461	White	1.800 (45.7)	0.500 (12.7)	0.750 (19.1)	1	1500	B30-R4300
Fig. 14c	B33-276-461	B-461	White	2.625 (66.7)	1.000 (25.4)	1.000 (25.4)	1	1500	B30-R4300
Fig. 15c	B33-134-461	B-461	White	3.500 (88.9)	1.500 (38.1)	1.250 (31.8)	1	1000	B30-R4300
Polyester (B-490):									
Fig. 7	B33-126-490	B-490	White	0.900 (22.9)	0.500 (12.7)	0.500 (12.7) dia.	1	2500	B30-R4300
Fig. 2	B33-154-490	B-490	White	1.250 (31.8)	0.375 (9.5)	-	1	1500	B30-R4300
Fig. 2	B33-155-490	B-490	White	1.625 (41.3)	0.600 (15.2)	-	1	1500	B30-R4300
Fig. 2	B33-156-490	B-490	White	1.900 (48.2)	1.000 (25.4)	-	1	1500	B30-R4300
Fig. 2	B33-157-490	B-490	White	2.200 (55.9)	1.500 (38.1)	-	1	1000	B30-R4300
Fig. 2	B33-158-490	B-490	White	3.750 (95.3)	1.750 (44.4)	-	1	1100	B30-R4300
Polyester (B-492):									
Fig. 5	B33-143-492	B-492	White	0.375 (9.5) dia.	-	-	4	1500	B30-R6400
Fig. 7	B33-182-492	B-492	White	0.500 (12.7)	1.000 (25.4)	0.44 (11.17) dia	1	1500	B30-R6400
Fig. 2	B33-180-492	B-492	White	0.900 (22.9)	1.000 (25.4)	-	1	1500	B30-R6400
Fig. 25a	B33-152-492	B-492	White	1.000 (25.4)	0.375 (9.5)	-	2	2500	B30-R6400
Fig. 7	B33-163-492	B-492	White	1.000 (25.4)	0.375 (9.5)	0.375 (9.5) dia.	1	1500 sets	B30-R6400
Fig. 7	B33-181-492	B-492	White	1.000 (25.4)	0.500 (12.7)	0.50 (12.7) dia	1	1500 sets	B30-R6400
Fig. 2	B33-59-492	B-492	White	1.000 (25.4)	0.500 (12.7)	-	1	5000	B30-R6400
Fig. 2	B33-179-492	B-492	White	1.000 (25.4)	1.000 (25.4)	-	1	1900	B30-R6400
Fig. 2	B33-156-492	B-492	White	1.900 (48.3)	1.000 (25.4)	-	1	1500	B30-R6400
Polypropylene (B-7425):									
Fig. 2	B33-257-7425	B-7425	White	0.825 (21.0)	0.250 (6.4)	-	1	1500	B30-R4300
Fig. 25a	B33-152-7425	B-7425	White	1.000 (25.4)	0.375 (9.5)	-	2	2000	B30-R4300
Fig. 2	B33-59-7425	B-7425	White	1.000 (25.4)	0.500 (12.7)	-	1	2000	B30-R4300
Fig. 25a	B33-88-7425	B-7425	White	1.000 (25.4)	0.750 (19.1)	-	2	2000	B30-R4300
Fig. 2	B33-256-7425	B-7425	White	1.300 (33.0)	0.600 (15.2)	-	1	1500	B30-R4300
Fig. 25a	B33-37-7425	B-7425	White	1.500 (38.1)	0.500 (12.7)	-	2	1500	B30-R4300

All part numbers above are compatible with BradyPrinter i3300 and BBP®33. Parts may also be compatible with BradyPrinter S3000, BradyPrinter S3100, BBP®30, BBP®31, BBP®35 and BBP®37 printers. Visit BradyID.com to confirm compatibility.

Centrifuge and PCR Tube Labels (B-499 and B-7425)

Designed with ultra-thin material that prevents vials from jamming in centrifuges or racks, these labels withstand harsh temperatures and chemicals without falling off, fading or smearing.

- **B-499 Nylon Cloth:** Thick white nylon cloth for easy handling and conformability
- **B-7425 Polypropylene:** Moderate chemical resistance, ideal for labeling dry, room temperature specimen containers that withstand temperature ranges from -196°C to 121°C (-320°F to 248°F). Chemical resistance to ethanol, DMSO, IPS, short-term xylene, 10% formalin, 50% acetic acid and toluene

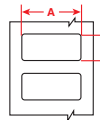

Figure 2

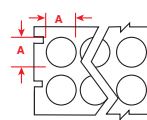

Figure 5

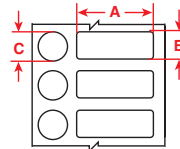

Figure 24



Diagram	Catalog #	B#	Color	Label Width A Inch (mm)	Label Height B Inch (mm)	Vial Top Dia. C Inch (mm)	Labels Per Row	Labels Per Roll	Rec. Ribbon
Nylon Cloth (B-499):									
Fig. 5	B33-143-499	B-499	White	0.375 (9.5)	-	-	4	1500	B30-R6000
Fig. 5	B33-144-499	B-499	White	0.500 (12.7)	-	-	3	1500	B30-R6000
Polypropylene (B-7425):									
Fig. 2	B33-257-7425	B-7425	White	0.825 (21.0)	0.250 (6.4)	-	1	1500	B30-R4300
Fig. 2	B33-152-7425	B-7425	White	1.000 (25.4)	0.375 (9.5)	-	2	2000	B30-R4300
Fig. 24	B33-249-7425	B-7425	White	1.000 (25.4)	0.375 (9.5)	0.375 (9.5) dia.	1	1500	B30-R4300
Fig. 2	B33-59-7425	B-7425	White	1.000 (25.4)	0.500 (12.7)	-	1	2000	B30-R4300
Fig. 24	B33-251-7425	B-7425	White	1.000 (25.4)	0.500 (12.7)	0.440 (11.1) dia.	1	1500	B30-R4300
Fig. 2	B33-179-7425	B-7425	White	1.000 (25.4)	1.000 (25.4)	-	1	1500	B30-R4300
Fig. 2	B33-256-7425	B-7425	White	1.300 (33.0)	0.600 (15.2)	-	1	1500	B30-R4300
Fig. 2	B33-37-7425	B-7425	White	1.500 (38.1)	0.500 (12.7)	-	2	1500	B30-R4300
Fig. 2	B33-136-7425	B-7425	White	1.500 (38.1)	0.750 (19.1)	-	1	1500	B30-R4300
Fig. 2	B33-258-7425	B-7425	White	1.500 (38.1)	1.750 (44.5)	-	1	900	B30-R4300
Fig. 2	B33-137-7425	B-7425	White	2.000 (50.8)	1.000 (25.4)	-	1	1500	B30-R4300

Microscope Slide Labels (B-481)

- Designed specifically to identify slides and to resist exposure to harsh chemicals during the slide-staining process
- Performs well in stains such as hematoxylin and eosin
- Extreme chemical resistance withstands the rigors of typical deparaffinization, including ethanol, xylene and H&E staining processes

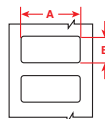

Figure 2

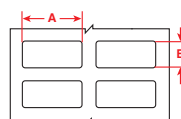

Figure 25



Diagram	Catalog #	B#	Color	Label Width A Inch (mm)	Label Height B Inch (mm)	Labels Per Row	Labels Per Roll	Rec. Ribbon
Fig. 2	B33-194-481	B-481	White	0.900 (22.9)	0.750 (19.1)	1	2000	B30-R6400
Fig. 25	B33-141-481	B-481	White	0.900 (22.9)	0.900 (22.9)	2	1500	B30-R6400

All part numbers above are compatible with BradyPrinter i3300 and BBP®33. Parts may also be compatible with BradyPrinter S3000, BradyPrinter S3100, BBP®30, BBP®31, BBP®35 and BBP®37 printers. Visit BradyID.com to confirm compatibility.

Dissolvable Paper Labels (B-403)

- Designed for temporary applications where easy removal, re-identification or waste reduction are valued
- Ideal for labeling vials, tubes or general glassware, temporary asset tracking, animal housing identification, and general use
- Completely dissolves in warm water within 30 seconds, leaving no adhesive residue

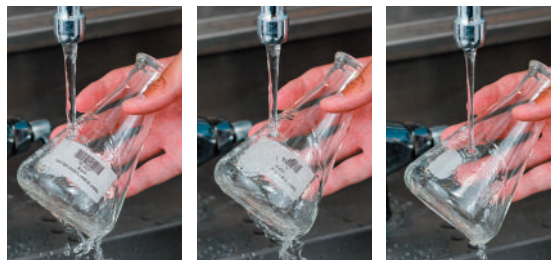
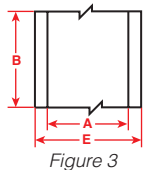
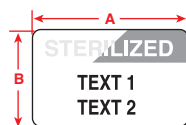

Diagram	Catalog #	B#	Color	Label Width A Inch (mm)	Roll Length B Inch (mm)	Labels Per Roll	Rec. Ribbon
Fig. 3	B30C-1125-403-WT	B-403	White	1.125 (28.575)	100 (30.5)	1 (cont.)	B30-R4300
Fig. 3	B30C-2250-403-WT	B-403	White	2.250 (57.15)	100 (30.5)	1 (cont.)	B30-R4300
Fig. 3	B30C-3000-403-WT	B-403	White	3.000 (76.2)	100 (30.5)	1 (cont.)	B30-R4300
Fig. 3	B30C-4000-403-WT	B-403	White	4.000 (101.6)	100 (30.5)	1 (cont.)	B30-R4300

Sterilization Indicating Labels (B-7425-AC)

- Specially designed with a pre-printed “sterilized” header that indicates steam sterilization with a color-changing pre-printed header when autoclaved at 121.5° C (250.7° F) for 10 minutes
- Withstands temperature ranges from -196° C to 121° C (-320° F to 248° F)
- For use in LN₂, freezers, autoclave and hot water baths
- Chemical resistance to ethanol, DMSO, IPS, short-term xylene, 10% formalin, 50% acetic acid and toluene



Note: Label dimensions include the “Sterilized” indicating area.

Diagram	Catalog #	B#	Color	Label Width A Inch (mm)	Label Height B Inch (mm)	Labels Per Row	Labels Per Roll	Rec. Ribbon
Fig. 29a	B33-235-7425-AC	B-7425-AC	White	1.500 (38.1)	1.000 (25.4) *	1	1250	B30-R4300
Fig. 29a	B33-137-7425-AC	B-7425-AC	White	2.000 (50.8)	1.000 (25.4) *	1	1500	B30-R4300

Tissue Cassette Labels (B-482)

- White polyester label with superior resistance to tissue processing chemicals and embedding procedures. Use with the BSP™31 Label Attachment system for pre-process tissue cassette ID

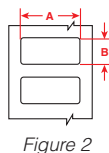

Diagram	Catalog #	B#	Color	Label Width A Inch (mm)	Label Height B Inch (mm)	Labels Per Row	Labels Per Roll	Rec. Ribbon
Fig. 2	B33-199-482	B-482	White	1.050 (26.7)	0.250 (6.4)	1	3000	B30-R6400
Fig. 2	B33-213-482	B-482	White	1.050 (26.7)	0.313 (8)	1	3000	B30-R6400

All part numbers above are compatible with BradyPrinter i3300 and BBP®33. Parts may also be compatible with BradyPrinter S3000, BradyPrinter S3100, BBP®30, BBP®31, BBP®35 and BBP®37 printers. Visit BradyID.com to confirm compatibility.

General Identification for Laboratory Storage, Equipment and Safety Labels (B-499, B-595, B-7569)

- Super strong adhesives and colors ideal for marking laboratory equipment, containers, hoses and lab storage cabinets, shelves and drawers
- GHS labels available for marking chemicals in the lab and shipment boxes when collaborating with other labs
- Pre-printed sign header labels make your safety and housekeeping reminders stand out and stay put!

B-499: Service temp: -40°F to 193°F
B-595: Service temp: -40°F to 180°F
B-7569: Service temp: -4°F to 167°F

Agency approvals:
 Agency approvals:

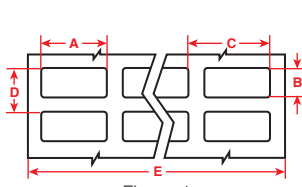

Figure 1

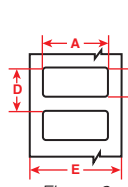

Figure 2

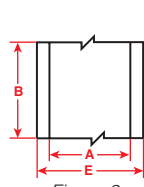

Figure 3

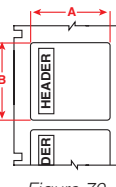

Figure 70

Diagram	Catalog #	B#	Color / Legend	Label Width A Inch (mm)	Label Height B Inch (mm)	Horiz. Repeat C Inch (mm)	Vert. Repeat D Inch (mm)	Web Width E Inch (mm)	Roll Length B Feet (m)	Labels Per Row	Labels Per Roll	Rec. Ribbon
Nylon Cloth - Permanent adhesive (B-499):												
Fig. 1	B33-68-499	B-499	White	0.500 (12.7)	0.750 (19.1)	0.600 (15.2)	0.875 (22.2)	2.500 (63.5)	–	4	1500	B30-R6000
Fig. 1	B33-165-499	B-499	White	0.800 (20.3)	1.437 (36.5)	0.900 (22.9)	1.562 (39.7)	3.700 (94.0)	–	4	2500	B30-R6000
Fig. 2	B33-125-499	B-499	White	0.900 (22.9)	0.500 (12.7)	–	–	–	–	1	1500	B30-R6000
Fig. 1	B33-126-499	B-499	White	0.900 (22.9)	0.500 (12.7)	–	–	–	–	2	1500	B30-R6000
Fig. 2	B33-163-499	B-499	White	1.000 (25.4)	0.375 (9.5)	–	–	–	–	1	1500	B30-R6000
Fig. 1	B33-152-499	B-499	White	1.000 (25.4)	0.375 (9.5)	–	–	–	–	2	1500	B30-R6000
Fig. 2	B33-136-499	B-499	White	1.500 (38.1)	0.750 (19.1)	–	0.875 (22.2)	1.770 (45.0)	–	1	1500	B30-R6000
Fig. 2	B33-137-499	B-499	White	2.000 (50.8)	1.000 (25.4)	–	1.125 (28.6)	2.200 (55.9)	–	1	1100	B30-R6000
Fig. 2	B33-125-499	B-499	White	2.000 (50.8)	0.250 (6.4)	–	–	–	–	1	1500	B30-R6000
Indoor/Outdoor Vinyl (B-595):												
Fig. 3	B30C-500-595-WT	B-595	White	0.500 (12.7)	–	–	–	–	100 (30.5)	–	1 roll (cont.)	B30-R10000
Fig. 3	B30C-1125-595-WT	B-595	White	1.125 (28.6)	–	–	–	–	100 (30.5)	–	1 roll (cont.)	B30-R10000
Fig. 3	B30C-500-595-YL	B-595	Yellow	0.500 (12.7)	–	–	–	–	100 (30.5)	–	1 roll (cont.)	B30-R10000
Fig. 3	B30C-1125-595-YL	B-595	Yellow	1.125 (28.6)	–	–	–	–	100 (30.5)	–	1 roll (cont.)	B30-R10000
Fig. 3	B30C-500-595-RD	B-595	Red	0.500 (12.7)	–	–	–	–	100 (30.5)	–	1 roll (cont.)	B30-R10000-WT
Fig. 3	B30C-1125-595-RD	B-595	Red	1.125 (28.6)	–	–	–	–	100 (30.5)	–	1 roll (cont.)	B30-R10000-WT
Fig. 3	B30C-500-595-BL	B-595	Blue	0.500 (12.7)	–	–	–	–	100 (30.5)	–	1 roll (cont.)	B30-R10000-WT
Fig. 3	B30C-1125-595-BL	B-595	Blue	1.125 (28.6)	–	–	–	–	100 (30.5)	–	1 roll (cont.)	B30-R10000-WT
Fig. 3	B30C-500-595-GN	B-595	Green	0.500 (12.7)	–	–	–	–	100 (30.5)	–	1 roll (cont.)	B30-R10000-WT
Fig. 3	B30C-1125-595-GN	B-595	Green	1.125 (28.6)	–	–	–	–	100 (30.5)	–	1 roll (cont.)	B30-R10000-WT
Pre-Printed Pre-Cut Blank Sign Headers (B-595):												
Fig. 70	B30-241-595-ANSIDA	B-595		2.250 (57.5)	3.000 (76.2)	–	–	–	–	1	300	B30-R10000
Fig. 70	B30-25-595-ANSIDA	B-595		4.000 (101.6)	6.000 (152.4)	–	–	–	–	1	175	B30-R10000
Fig. 70	B30-241-595-ANSINO	B-595		2.250 (57.5)	3.000 (76.2)	–	–	–	–	1	300	B30-R10000
Fig. 70	B30-25-595-ANSINO	B-595		4.000 (101.6)	6.000 (152.4)	–	–	–	–	1	175	B30-R10000
Pre-Printed GHS/CLP Chemical (B-7569):												
L4B Diamond + Text	B30-260-7569-CLP4B	B-7569		2.170 (55.0)	3.350 (85.0)	–	–	–	–	1	340	B30-R10000
L4B Diamond + Text	B30-261-7569-CLP4B	B-7569		2.950 (75.0)	4.330 (110.0)	–	–	–	–	1	270	B30-R10000
L4C Diamond + Text	B30-18-7569-CLP4C	B-7569		1.000 (25.4)	3.000 (76.2)	–	–	–	–	1	1000	B30-R10000

(B-595) U.S. Patent Nos. 5,823,689; 6,570,602. Additional Patents Pending, more parts on page 24. For more sign headers see pages 23 and 26. And for more GHS labels see page 29.

All part numbers above are compatible with BradyPrinter i3300 and BBP®33. Parts may also be compatible with BradyPrinter S3000, BradyPrinter S3100, BBP®30, BBP®31, BBP®35 and BBP®37 printers. Visit BradyID.com to confirm compatibility.

Print ribbons

“Drop and Click” print ribbons for 5-second ribbon supply changes

- Tough, smear-proof ribbons that produce long-lasting printed text and can withstand years in industrial areas and outdoor conditions
- Self-contained cartridges drop straight into printer with a “click”
- No calibrating, no threading, no wasted feeding, no hassles and the ink will always be facing the right direction!
- Printer notifies user if installed ribbon is not recommended for installed labels

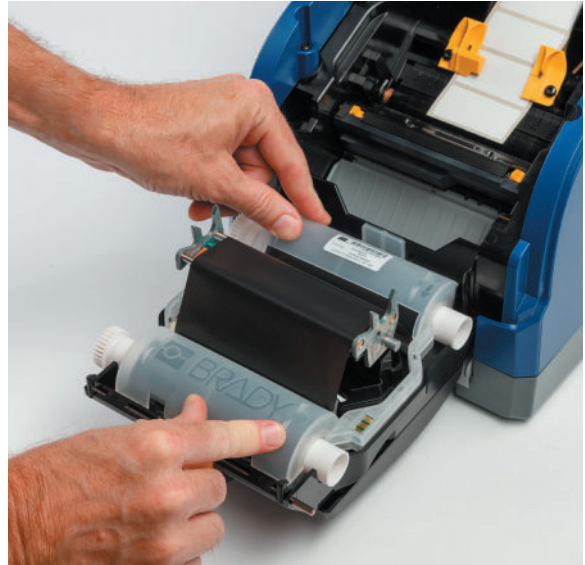

Installs in 5 seconds...just snap into place!

Single Color Print Ribbons

Catalog #	Color	Size Inch (mm)	Length Feet (m)
B30-R10000	Black	4.330 (109.9)	200 (60.9)
B30-R6000	Black	4.330 (109.9)	200 (60.9)
B30-R6200	Black	4.330 (109.9)	200 (60.9)
B30-R6400	Black	4.330 (109.9)	200 (60.9)
B30-R6600	Black	4.330 (109.9)	200 (60.9)
B30-R4300	Black	4.330 (109.9)	200 (60.9)
B30-R10000-WT	White	4.330 (109.9)	200 (60.9)
B30-R4400-WT	White	4.330 (109.9)	200 (60.9)
B30-R6700-WT	White*	4.330 (109.9)	200 (60.9)
B30-R4500-SV	Silver*	4.330 (109.9)	200 (60.9)
B30-R10000-RD	Red	4.330 (109.9)	200 (60.9)
B30-R10000-GN	Green	4.330 (109.9)	200 (60.9)
B30-R10000-BL	Blue	4.330 (109.9)	200 (60.9)
B30-R10000-YL	Yellow**	4.330 (109.9)	200 (60.9)
B30-R10000-YL2	Yellow**	4.330 (109.9)	200 (60.9)
B30-R10000-OR	Orange	4.330 (109.9)	200 (60.9)
B30-R10000-MA	Magenta	4.330 (109.9)	200 (60.9)
B30-R10000-PRCCY	Process Cyan***	4.330 (109.9)	200 (60.9)
B30-R10000-PRCYEL	Process Yellow***	4.330 (109.9)	200 (60.9)
B30-R10000-PRCMAG	Process Magenta***	4.330 (109.9)	200 (60.9)

* B30-R4500-SV ribbon for use with B-342 black sleeves only; B30-R6700-WT ribbon for use with B-345 black sleeves only.

** B30-R10000-YL for printing yellow onto white. B30-R10000-YL2 for printing yellow onto other colors of B-595.

*** Process ribbons print a much lighter shade. They are designed to be used together with other process ribbons and black ribbon to lay down a dot pattern for printing “blended” colors and process color objects with the BBP35 or BBP37 printers.



Print ribbon / label material compatibility

B-# Material		B30-R4300 (Black)	B30-R6000 (Black)	B30-R6200 (Black)	B30-R6400 (Black)	B30-R6600 (Black)	B30-R10000 (Black)	B30-R4500-SV* (Silver)	B30-R4400-WT (White)	B30-R6700-WT* (White)	B30-R10000-WT (White)	B30-R10000-YL (Yellow)	B30-R10000-YL2 (Yellow)	B30-R10000 (Colors)
B-342	Polyolefin	●	-	-	-	-	-	●	-	-	-	-	-	-
B-344	Polyolefin	-	-	-	-	●	-	-	-	●	-	-	-	-
B-345	Polyolefin	-	●	-	-	-	-	-	●	-	-	-	-	-
B-403	Paper	●	-	-	-	-	-	-	-	-	-	-	-	-
B-422	Polyester	-	●	-	-	-	-	-	●	-	-	-	-	-
B-423	Glossy White Polyester	-	●	●	-	-	-	-	-	-	-	-	-	-
B-424	Matte White Paper	●	-	-	-	-	-	-	-	-	-	-	-	-
B-425	Polypropylene	●	-	-	●	-	-	-	-	-	-	-	-	-
B-427	Vinyl	●	-	-	-	-	-	-	-	-	-	-	-	-
B-428	Metallized Polyester	●	-	-	-	-	-	-	-	-	-	-	-	-
B-430	Polyester	-	●	-	-	-	-	-	-	-	-	-	-	-
B-432	Glossy Clear Polyester	-	●	-	-	-	-	-	●	-	-	-	-	-
B-434	Glossy Metallized Polyester	-	●	-	-	-	-	-	-	-	-	-	-	-
B-437	Polyvinylfluoride	●	-	-	-	-	-	-	-	-	-	-	-	-
B-438	Tamper Evident Metallized Polyester	●	-	-	-	-	-	-	-	-	-	-	-	-
B-461	Polyester	●	-	-	-	-	-	-	-	-	-	-	-	-
B-472	Polyimide	●	-	-	-	-	-	-	-	-	-	-	-	-
B-481	Polyester	-	-	-	●	-	-	-	-	-	-	-	-	-
B-482	Polyester	-	-	-	●	-	-	-	-	-	-	-	-	-
B-483	Glossy White Polyester	-	●	-	-	-	-	-	-	-	-	-	-	-
B-483	ToughStripe® Printable Floor Marking Tape	-	●	-	-	-	-	-	●	-	-	-	-	-
B-484A	Glossy White Polyester	-	●	-	-	-	-	-	-	-	-	-	-	-
B-486	Matte Metallized Polyester	●	-	-	-	-	-	-	-	-	-	-	-	-
B-489	Matte White Polyester	●	-	-	-	-	-	-	-	-	-	-	-	-
B-490	Polyester	●	-	-	-	-	-	-	-	-	-	-	-	-
B-492	Polyester	-	-	-	●	-	-	-	-	-	-	-	-	-
B-498	Cloth	-	-	●	-	-	-	-	-	-	-	-	-	-
B-499	Nylon	●	●	-	-	-	-	-	-	-	-	-	-	-
B-509	Printable Magnetic	-	-	-	-	-	●	-	-	-	-	-	-	●**
B-526	Photoluminescent Polyester	-	-	-	-	-	●	-	-	-	-	-	-	●**
B-549	Cold Temperature Polyester	-	-	-	-	-	●	-	-	-	●	-	-	●**
B-551	Non-Adhesive Tag	-	-	-	-	-	●	-	-	-	-	-	-	●**
B-565	Metallized Polyester	-	-	-	-	-	●	-	-	-	-	-	-	-
B-569	Low-Halide Polyester	-	-	-	-	-	●	-	-	-	●	-	-	●**
B-581	Repositionable Vinyl	-	-	-	-	-	●	-	-	-	●	-	-	●**
B-584	Retro Reflective	-	-	-	-	-	●	-	-	-	-	-	-	●**
B-593	Raised Panel	-	●	-	-	-	-	-	●	-	-	-	-	-
B-595	Outdoor Vinyl	-	-	-	-	-	●	-	-	-	●	●***	●***	●**
B-717	Polyimide	-	●	-	-	-	-	-	-	-	-	-	-	-
B-718	Polyimide	-	●	-	-	-	-	-	-	-	-	-	-	-
B-719	Polyimide	-	●	-	-	-	-	-	-	-	-	-	-	-
B-724	Matte Amber Polyimide	●	-	-	-	-	-	-	-	-	-	-	-	-
B-727	Glossy White Polyimide	-	●	-	-	-	-	-	-	-	-	-	-	-
B-854	ToughWash® Metal Detectable	-	●	-	-	-	-	-	-	-	-	-	-	-
B-855	ToughWash	-	●	-	-	-	-	-	-	-	-	-	-	-
B-7425	Polypropylene	-	-	-	●	-	-	-	-	-	-	-	-	-
B-7425-AC	Polypropylene	-	-	-	●	-	-	-	-	-	-	-	-	-
B-7569	Vinyl Film	-	-	-	-	-	●	-	-	-	-	-	-	-
B-7641	Polyolefin	●	●	-	-	●	-	-	-	-	-	-	-	-
B-7642	Polyolefin	●	-	-	●	-	-	-	-	-	-	-	-	-
B-7643	Polyurethane	-	●	-	-	-	-	-	●	-	-	-	-	-

Refer to the corresponding B-number Tech Data Sheet for complete material information at BradyID.com/techdata.

* B30-R4500-SV ribbon for use with B-342 black sleeves only; B30-R6700-WT ribbon for use with B-345 black sleeves only.

** Colored ribbons optimized for use on white material. Test use on other material colors for suitability to your application.

*** Use B30-R10000-YL for printing yellow onto white. Use B30-R10000-YL2 for printing yellow onto other colors of B-595.

Software for easier label creation

Innovation is at the core of our business. And software is no exception. Our intuitive software options make label creation even easier and more efficient. When you pair the BradyPrinter i3300 Industrial Label Printer with these software options, you get automatic label setup and guidance through the label creation process to minimize errors and make label creation a snap.



Brady Workstation Label Creation Software

Brady Workstation revolutionizes label and sign creation and printing by offering a variety of suites and apps that are easy and efficient to use. Choose and customize the tools you use to complete tasks exactly as you want without having to use print drivers. Try these software options:



Product and Wire Identification Suite – When you need to create product labels, wire and cable markers, and panel labels this suite is your go-to solution. It allows you to create basic text labels or labels with graphics and custom formatting and serialize and import data.



Scan and Print Suite – This suite allows you to consume data from a barcode scanner, keyboard or custom script to quickly populate your own custom label templates as part of a labeling workflow. Whether you need to replicate labels for lab specimens, re-label supplied parts for product assembly or label products based off work orders, this software suite can solve your workflow needs.



Laboratory Identification Suite – Ensure labels for all your lab samples and equipment are crisp, clear and contain all necessary information. Easily design and create labels for your cryovials, centrifuge tubes and bottles, conicals, slides and other samples in your laboratory.



Safety and Facility Identification Suite – Keep your facility safe and compliant with the Safety and Facility Identification Suite. This group of apps makes it easy to create custom signs, labels, pipemarkers, Lean / 5S labels and outdoor-grade facility labels. Choose this suite to add visual safety guidance to your facility.



GHS Labels App – Creating GHS labels is now surprisingly simple. We've streamlined the process so you can easily enter the data once from your SDS sheets, then create and print any size GHS label at any time. You can also auto-populate your GHS label using the built-in chemical database. Need labels with multiple languages? Those are also supported in the app.

Other apps and suites are available:



1. Go to **Workstation.BradyID.com**.



2. Fill the workstation with the apps and suites you want and leave out the ones you don't.

For more information on Brady Workstation apps and suites, go to Workstation.BradyID.com.

Printer specifications

Model(s):	
Model name	i3300 Industrial Label Printer
Media alignment	Center justified
User Interface:	
Display type	Touchscreen color LCD
Display size (diagonal)	3.5 in. (88.90 mm)
Display resolution (h x w)	240 x 320 pixels
Display languages	Bulgarian, Chinese (simplified), Chinese (traditional), Croatian, Czech, Danish, Dutch, English, Estonian, Finnish, French (Canadian), French, German, Hungarian, Italian, Korean, Norwegian, Polish, Portuguese (Brazilian), Portuguese (Iberian), Romanian, Russian, Slovakian, Slovenian, Spanish (Iberian), Spanish (Latin America), Swedish, Thai, Turkish
Display status bar	Ribbon and label part number installed, amount of supplies remaining, Wi-Fi connection, Ethernet connection, receiving data icon, ready state/error state,
Print Head / Printing Characteristics:	
Print resolution	300 dpi
Print method	Thermal transfer
Print color capability	Single print color
Print speed	Up to 4 in./sec. (101.60 mm/sec.)
Print width (max, cross-web)	4.015 in. (101.98 mm)
Print length (max, down-web)	5.0 ft. (1.52 m)
Media cut-off	Auto cutter built in (all models)
Media Characteristics:	
Intelligent printing capability	Yes - reads datachip on supplies for no waste printing and auto label setup in software
Media loading/handling	Labels: In cartridge, drops into place, 15 sec. changeover Ribbon: In cartridge, snaps into place, 5 sec. changeover
Media width (cross-web incl liner)	0.71 to 4.25 in. (18.03 to 107.95 mm)
Label width (cross-web)	0.25 in. to 4.25 in. (6.35 mm to 107.95 mm) continuous liner-less media 0.25 in. to 4.015 in. (6.35 mm to 101.98 mm) other media
Label length (down-web)	0.25 in. (6.35 mm) min. die cut media 0.50 in. (12.7 mm) min. continuous media
Media thickness**	0.0024 in. to 0.031 in. max (0.061 mm to 0.787 mm) label media 0.070 in. max (1.778 mm) B-593 push button media 0.043 in. max (1.092 mm) heat shrink sleeves
Media roll o.d. (max)	4.30 in. (109.22 mm) when specifying a custom part
Media roll core i.d.	n/a (media integrated in cartridge roll)
Media roll winding	n/a (media integrated in cartridge roll)
Media styles	All media are on an integrated cartridge roll with part data on smart cell. Die cut media, continuous media, tagstock liner-mounted, tagstock linerless, perforated materials, adhesive labels, heat-shrink sleeves size 094 and larger (single and double-sided with 2-pass print), self-laminating cable labels, zip-tie cable tags, raised panel push button labels, rapido-style cable tags, Permashield style labels, pre-printed GHS labels, safety and facility identification outdoor grade labels
Media material types	PE (polyethylene), PET (polyester), PET Metallized, PU (polyurethane), PVC (vinyl), PVF (polyvinyl fluoride), PVDf (polyvinylidene fluoride), PP (polypropylene), PI (polyimide), Polyamide, Polyether Polyurethane (Heatex™), Raised Panel Push Button material, Paper, Destructible materials, Tamper-Evident and Tamper-Resistant materials, 8-10 year Outdoor Vinyl, 10-hour Glow-in-the-Dark material, Retroreflective labels, Printable Floor Marking Tape, Nylon and Vinyl cloth, Wash-Down materials, Extreme Temperature Laboratory materials, labels for lab staining (slides), other materials not listed
Media parts offering	800+ stock parts and custom (made-to-spec) parts
Ribbon Characteristics:	
Ribbon length (max)	200 ft. (60.96 m)
Ribbon roll o.d. (max)	n/a (ribbon integrated in cartridge)
Ribbon roll core i.d.	n/a (ribbon integrated in cartridge)
Ribbon width (cross-web)***	4.33 in. (109.98 mm)
Ink side	n/a (ribbon integrated in cartridge—guaranteed correct orientation to print head)

Electronics:	
Processor	32 bit 800 MHz clock rate
Memory (RAM)	512 MB
Data storage (IFFS)	195 MB
SD card slot (SDHC, SDXC)	n/a
Internal battery	For internal date and time (RTC)
Data storage when power off	Yes

Physical / Operational Characteristics:	
Dimensions (closed) (h x w x d)	9.5 in. x 9.0 in. x 12.0 in. (241.30 mm x 228.60 mm x 304.80 mm)
Weight (empty)	11.5 lbs
Power supply	101 to 240V AC, 50/60 Hz
Power consumption	<10W standby / 70W operating / 480W max
Operating environment	50 to 104° F (10 to 40° C) / 10 - 85% RH non condensing
Storage environment	-4 to 122° F (-20 to 50° C) / 15 - 90% RH non condensing
Transport environment	-4 to 122° F (-20 to 50° C) / 15 - 90% RH non condensing
Agency approvals	CE, FCC class A, cUL. Contact Brady for up-to-date list of environmental compliance information and agency approvals and/or marks covering over 75 countries (awarded or applied for)

Fonts and Graphics:	
Font types (resident)	Arial, Courier New, Times New Roman, Trebuchet MS, Verdana, Tahoma
Font types (storable to printer)	TrueType fonts storable to printer via jump drive
Font attributes	Bold, italic, underlined
Character sets	ASCII character set
Graphic elements	Arrow, line, rectangle, square, circle, ellipse, diamond, dot, star, triangle, seal, and cross
Graphic formats	BMP, GIF, JPEG, PNG

Barcodes:	
Barcode symbologies - linear	Code 39, Code 93, Code 128 A, B, C, EAN-8, EAN-13, EAN/JAN 13, JAN-8, JAN-13, HIBC, Interleaved 2 of 5, Interleaved 2 of 5 w check digit, UPC A, Aztec, QR Code, datamatrix
Barcode symbologies - 2D	Aztec, QR Code, pdf 417
Barcode attributes	Sizing: variable in height and ratio Rotation: 0°, 90°, 180°, 270° human-readable and human-readable location density

Interfaces and Connectivity:	
USB 2.0 hi-speed device port	For PC connect
2 x USB host (back panel)	For scanner, keyboard, USB memory stick
1 x Ethernet 100 BASE-T	For networking
Wireless	Factory installed Wi-Fi 802.11b/g/n (wireless printer model only)

Software and Firmware:	
Label creation software	Brady Workstation (v4.4 or newer) & Workstation apps
WHQL certified Windows® drivers****	Windows 7, 8, 8.1, 10, Server 2008, 2008 R2, 2012, 2012 R2, 2017
Printer command language	BPL - scripting commands for sending scripts to the printer

Options / Accessories:	
Replacement print heads	Factory replaceable via Brady tech repair
Replacement print rollers***	4.53 in. (115 mm) width, factory replaceable via Brady tech repair if worn
Auto cutter	Built-in auto cutter (on all models)

** User should test the media with the application. Print performance on small labels or a part that is below the minimum label dimension spec. is dependent on multiple factors, including print speed, quantity in print run, heat setting and the size/layout of the printed elements.

*** Use narrow print roller with narrow media, but to avoid head damage, ALWAYS be sure roller is wider than total media width, and ribbon is wider than the roller width.

**** Windows® is a registered trademark of Microsoft Corporation.

We identify and protect premises, products and people.

For more information or to learn more about our innovative products, visit BradyID.com or call 1-888-272-3946.



Y4698871 MS4698871

USA
Customer Service: 1-888-272-3946
Inside Sales: 1-888-311-0775
BradyID.com

Canada
Customer Service: 1-800-263-6179
BradyCanada.ca

Mexico
Customer Service: 1-800-262-7777
Inside Sales: 1-800-262-7777 ext 177
BradyLatinAmerica.com

